

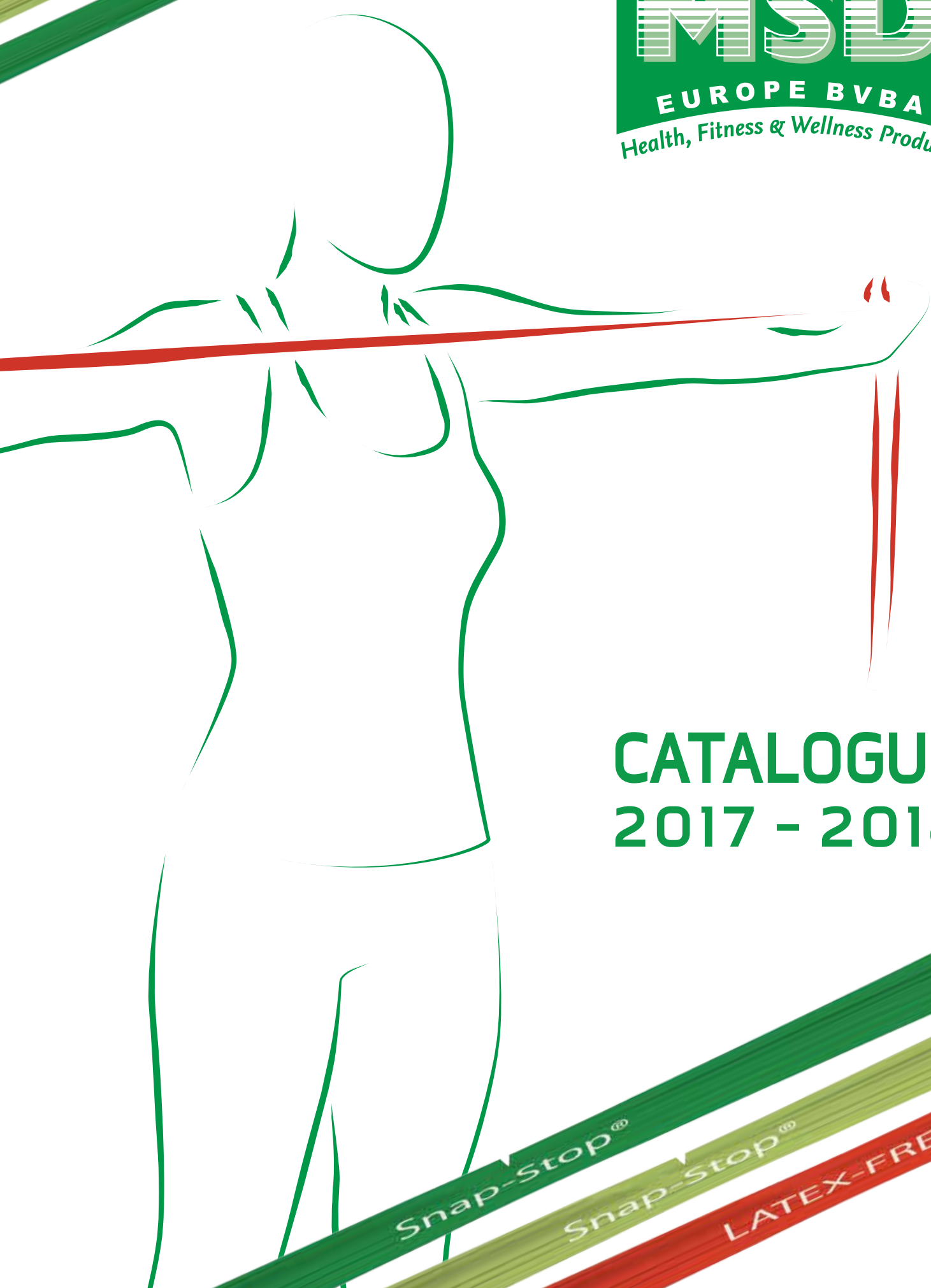

MSD

EUROPE BVBA

Health, Fitness & Wellness Products



CATALOGUE 2017 - 2018

Snap-Stop®

Snap-Stop®

LATEX-FREE

Your Manufacturer and Master Distributor for Rehab & Therapy and Sports & Fitness Products!



Sandra Vrancaert
sandra.vrancaert@msd-europe.com



Tom Benoy
sales@msd-europe.com



Tom Lambrechts
tom.lambrechts@msd-europe.com



Hervé De Braekeleer
marketing@msd-europe.com



Patrick Verlinden
info@msd-europe.com



Monique Breuer
customer.service@msd-europe.com



Manuela Stobbelaar
logistics@msd-europe.com



Patrick Steenackers
Warehousing



Kenny Van Kerchove
Warehousing



MSD Europe
Westdijk 150
2830 Tisselt
Belgium - Europe
[T] +32 3 866 40 76

www.msd-europe.com
info@msd-europe.com

MSD
EUROPE



MSD North America, Inc
1100 Grape Avenue
St. Cloud, FL 34769, USA
[T] +1 407 922 5513
[F] +1 407 957 1170

www.msd-northamerica.com
info@msd-northamerica.com



Martha Rodriguez
info@msd-northamerica.com

MSD
NORTH AMERICA



Marcel Vrancaert
International Business Manager
info@mv-consulting.be



Reet Juhkam
International Business Assistant
info@mv-consulting.be

MSD
INTERNATIONAL



MSD-BAND

RESISTIVE EXERCISE SYSTEM



MSD-BAND

RESISTIVE EXERCISE SYSTEM



LEADER IN TECHNOLOGY

What is Snap-Stop®?

Snap-Stop® makes exercising with bands much safer. This unique feature/benefit will avoid snapping, even if there's a cut or puncture. When working out with a resistive exercise band, the band has to endure extremely high tensions. A small cut can have a big consequence...

Our MSD-Band and MSD-Band Global are unique in their field. Thanks to extended research and development we achieved a special production process. This process results in a latex band that won't snap, even if there's a cut or puncture and it's exposed to high forces. This does not apply to a very old band, or band that has been exposed outdoors for some time, as well as abused bands. First advise still remains to use a fresh and clean sheet of band.



MSD-Band
Snap-Stop®



See for yourself:

Different brands, different purposes

BRANDS



MSD-Band products (Global & Latex-Free included) are mainly Resistive Exercise products. Lower resistances are focused on physiotherapy, while the heavier resistances are ideal for fitness training.



Manus labelled products are helpful devices for hand therapy after an injury. In addition to early rehabilitation, these product can be used for muscle building too.



Our Mambo Max products are the go-to-products for wellness, fitness and strength training at an affordable price tag. Combine various products for a complete workout, without leaving the house.

ONLINE

Find us Online



www.msd-band.com

The virtual home of our MSD-Band, MSD-Band Global and Manus product line. This B2C platform connects our distributors directly to the end users, with product information, a shop locator and numerous free downloadable exercises. The website has been upgraded and is mobile friendly.



www.mambomax.com

The virtual home of our Mambo Max product line. This B2C platform connects our distributors directly to the end users, with product information and numerous free downloadable exercises.

www.msd-europe.com

MSD Europe's B2B site, with all the available products, downloadable high resolution pictures and full catalogue.



www.msd-northamerica.com

The B2B site from our American division, with all the available products, downloadable high resolution pictures and full catalogue. This site is accessible for North America, Canada and Latin America.



Social Media



Here you will find our latest news and useful information. Like or follow our pages for a higher brand awareness to create a bigger demand. Our pages are continuously monitored to answer your questions as soon as possible. At first we will be active on Facebook and LinkedIn, other Social Media tools can be added afterwards.



By making our exercises available on our websites, we not only reduce our ecological footprint by cutting down on the number of unused prints, it allows us to keep costs low and offer you better value-for-money.

Extra Information

In order to keep all the information in this catalogue as clear and easy accessible as possible, we use a system of icons that are shown next to the product where applicable.



Contains multilingual instructions.



Packed in a polybag with full colour header.



Packaging contains printed exercises.



Packed in a full colour cardboard box.



Packed in a shrinkfoil wrap.



Downloadable exercises available on our websites.



Packed in a blister pack with full colour insert.



Comes with a pump.



Product Diameter
Product Height
Maximum Load

LEGEND



MSD-BAND

RESISTIVE EXERCISE SYSTEM



MSD-BAND

RESISTIVE EXERCISE SYSTEM



MSD-BAND

RESISTIVE EXERCISE SYSTEM

ONE-STOP-SHOP FOR ALL YOUR BANDS AND TUBES.

With MSD-Band, MSD-Band Global and MSD-Band Latex-Free, MSD Europe is the one-stop-shop for all resistive exercise bands. MSD Europe offers both original colour sequence and global colour sequence. In addition, we also offer a range of Latex-Free resistive exercise bands. Our tubes and loops are available in the Original and Global colour sequence.

The latex bands, tubes and (super)loops are made of high quality latex from huge rubber tree plantations in Malaysia. They have an extraordinary elasticity and linearity. Together with the unique Snap-Stop® feature, they are your ideal partner for your physiotherapy trainings or intensive work-outs. The various different resistances allow you to use MSD-Band for rehabilitation as well as for fitness.

MSD-Band Latex-Free is made from TPE, to the same high quality standards as the regular MSD-Band. Never before were the characteristics from Latex-Free bands so close to those from their latex counterpart.

Check www.msd-band.com to discover the complete range of products and all possible exercises.



MSD-Band

8 resistances (Tan - Gold)
5 lengths (1,5m - 2,5m - 5,5m - 22,5m - 45,5m)

MSD-Band Global

6 resistances (Peach - Grey)
4 lengths (1,5m - 2,5m - 5,5m - 45,5m)

MSD-Band Latex-Free

5 resistances (Yellow - Black)
3 lengths (1,5m - 5,5m - 45,5m)



ONE SOURCE FOR ALL

MSD-BAND RANGE

Do you tolerate latex?

Yes | No

Which colour do you prefer?

Original | Global

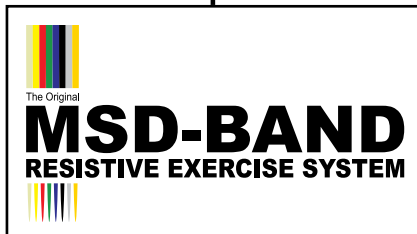

MSD-Band

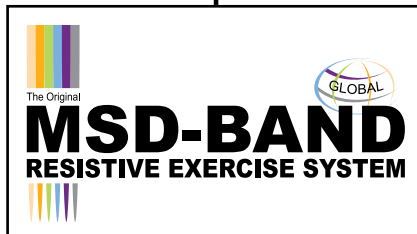

MSD-Band Global



MSD-Band Latex-Free

CHOOSE YOUR MSD-BAND

RESISTIVE EXERCISE

9



HAND EXERCISE

24



UPPER & LOWER BODY EXERCISE

32



WELLNESS

41



FITNESS

46



STRENGTH

59



THERMAL TREATMENT

63



MEASUREMENT INSTRUMENTS

67



SERIOUS STRONG ROTATION HANDLES

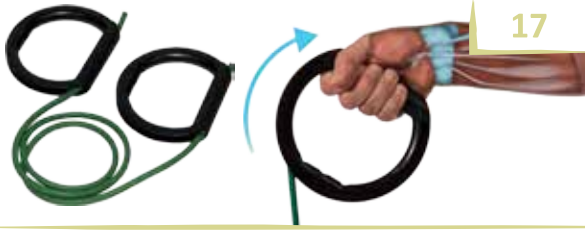

17

VARIGRIP - THERAPY

25



MSD WOODEN INCLINE BOARD - FIX

37



MAMBO MAX ERGONOMIC FOAM ROLLER

43



MAMBO MAX 3-IN-1 FOAM ROLLER

43



MAMBO MAX MASSAGE STICK

43



MAMBO MAX AB PEANUT BALL

47



MAMBO MAX WOODEN WORK STATION

49



MAMBO MAX WOODEN BALANCE BOARD UNI-DIRECTIONAL

53



PEARLPACK SPORT PACK - BACK WRAP - EYE MASK

65



MULTIPLE MEASUREMENT INSTRUMENTS

72, 76 - 78



RESISTANCE - MSD-BAND (GLOBAL) vs. MARKET LEADER

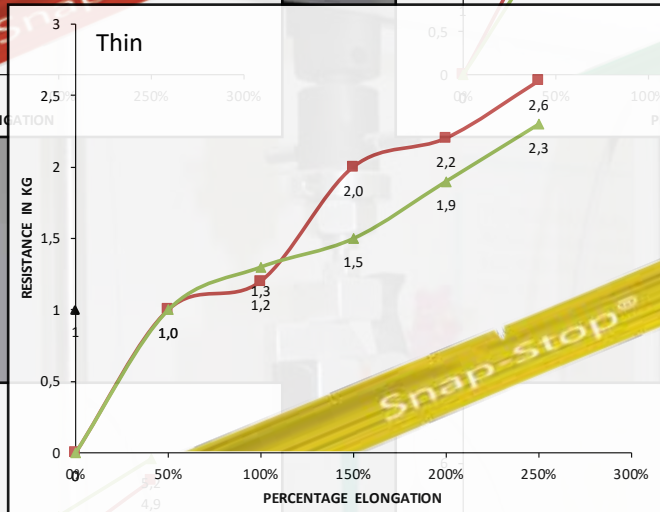
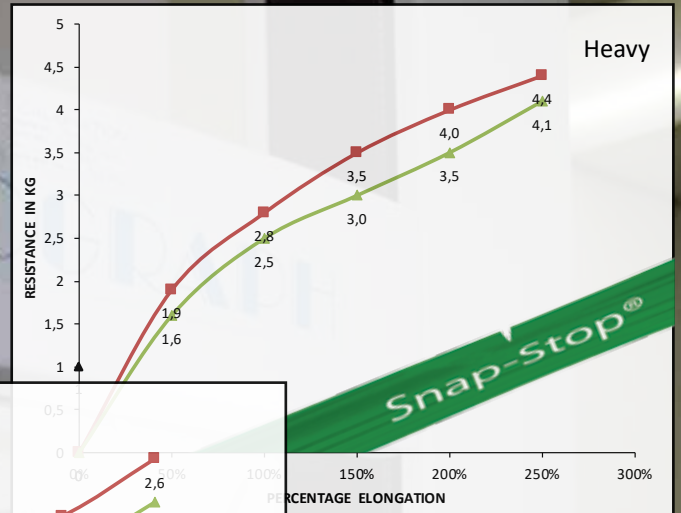
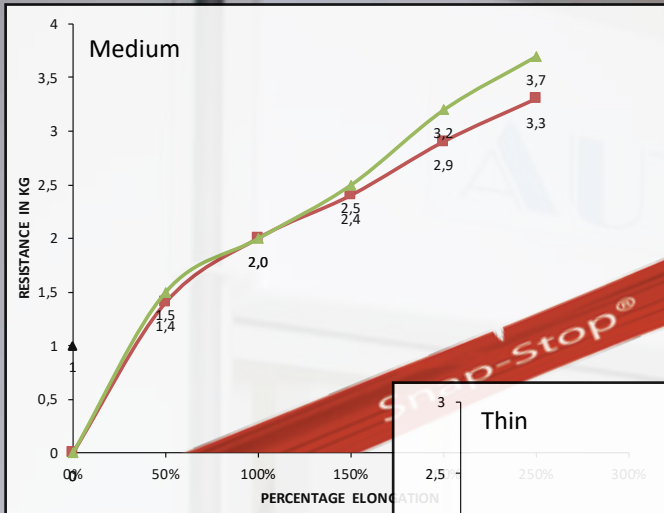

▲ MSD-Band
■ Market Leader

Thin
Medium
Heavy
Extra Heavy
Special Heavy

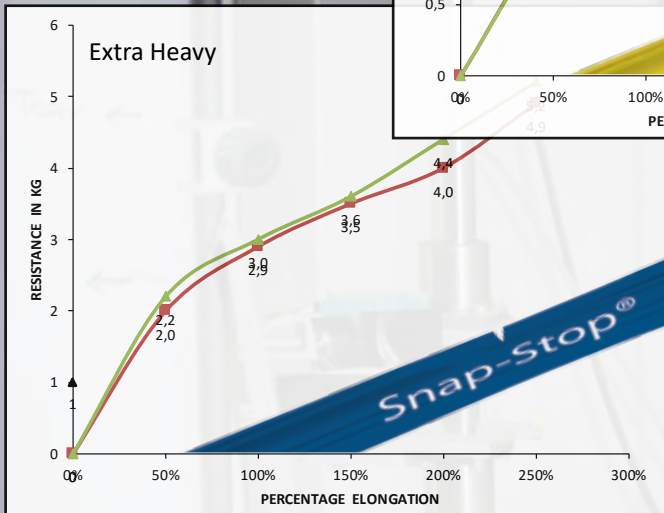

MSD-Band (Global) can be stretched up to 600% elongation! MSD-Band (Global) is therefore your perfect partner for a rehabilitation programme or a full body work-out. Even after an effective training with amazing results, the MSD-Band (Global) allows you to use the same band again. When you pre-stretch your band, you will be able to achieve higher forces without having to worry about the 'elastic stop', the point where the band feels like a regular string. Most competitor's bands are not to be stretched more than 3 times their resting length, while MSD-Band (Global) achieves easily the double, while maintaining its amazing elasticity.

These specifications apply to all MSD-Band (Global) resistances. The high-quality material enables you to have a much wider array of resistances and possibilities compared to the competitors. At the start of your exercise, the band already gives some resistance, which allows you to achieve much better results than when the band is at its resting length.

The Original

MSD-BAND

RESISTIVE EXERCISE SYSTEM

MSD-Band is a premium quality, low powder (in fact, less than 2mg/dm², so we're officially powder-free) latex resistive exercise band. The unique Snap-Stop[®] fabrication process makes this product extremely tear resistant. Using the MSD-Band for resistive exercises provides positive as well as negative forces on the muscles and improves the range of motion, the strength and the cooperation of the muscle groups. The 8 different resistance levels are determined by the thickness of the band. These bands are available in 5 lengths and come with a full colour manual.

Dispenser: 25 pieces of 1,5m high quality MSD-Band in a sealed polybag in a great OTC dispenser box.

1,5m: 10 pre-cut pieces of the same resistance or 5 pieces of different resistance. (yellow, red, green, blue and black) that come in separate polybags with header.

2,5m: 10 pre-cut pieces of the same resistance or 5 pieces of different resistance. (yellow, red, green, blue and black) that come in separate polybags with header.

5,5m: A small roll of our premium MSD-Band.

22,5m: A medium roll of our premium MSD-Band.

45,5m: A big roll of our premium MSD-Band.

COLOUR	TOTAL KG / ELONGATION %				
	50%	100%	150%	200%	250%
Yellow	1,0	1,3	1,5	1,9	2,3
Red	1,5	2,0	2,5	3,2	3,7
Green	1,6	2,5	3,0	3,5	4,1
Blue	2,2	3,0	3,6	4,4	5,2
Black	2,5	3,4	4,0	4,9	6,1
Silver	4,1	5,8	7,2	7,9	9,5
Gold	5,8	7,9	10,0	12,0	14,0



COLOUR	RESISTANCE	MSD-BAND					
		Dispenser	1,5m	2,5m	5,5m	22,5m	45,5m
Tan	Extra Thin	n/a	n/a	n/a	01-100501	n/a	01-104501
Yellow	Thin	01-100102	01-101502	01-100202	01-100502	01-102202	01-104502
Red	Medium	01-100103	01-101503	01-100203	01-100503	01-102203	01-104503
Green	Heavy	01-100104	01-101504	01-100204	01-100504	01-102204	01-104504
Blue	Extra Heavy	01-100105	01-101505	01-100205	01-100505	01-102205	01-104505
Black	Special Heavy	01-100106	01-101506	01-100206	01-100506	01-102206	01-104506
Silver	Super Heavy	n/a	01-101507	01-100207	01-100507	01-102207	n/a
Gold	Ultra Heavy	n/a	n/a	n/a	01-100508	01-102208	n/a
Set of 5 resistances (yellow to black)		n/a	01-101511	01-100211	n/a	n/a	n/a





The production of MSD-Band starts deep in the humid forests of Malaysia, where the best and strongest trees provide the natural latex rubber that will be processed from a milky fluid to your preferred resistive exercise band. When a tree is 5 - 6 years old, harvesting can begin: incisions are being made orthogonally in the bark of the tree, just deep enough to tap the latex vessels without harming the tree's growth. The fluid is collected in small buckets, a process known as rubber tapping.

natural
100%
biodegradable

"This is why we are confident when using the words 'premium quality' when referring to MSD-Band."

Did you know that rubber trees combat greenhouse gases and thereby slowing down global warming? Additionally, latex harvesting helps prevent deforestation.

Only the best quality latex is being selected for the MSD-Band. Production starts under the constant supervision of a team of scientists, ensuring an immaculate product quality.

Latex sheets are produced, powdered, washed, dried and cut to the exact width. The amount of powder used is below the 2mg/dm² limit, which makes the MSD-Band officially powder-free. Each batch of latex sheeting that is produced, is subject to the meticulous inspection of our scientists by a series of laboratory experiments: colour-coding, dryness, tensile strength, tearing resistance, snapping resistance, ...

During the rolling process, a 100% visual inspection is being conducted on both sides of the band. Indeed, before leaving the factory, every MSD-band has been completely analysed, checked and examined to ensure premium product quality.



The Original

MSD-BAND

RESISTIVE EXERCISE SYSTEM



CE

natural
100%
biodegradable

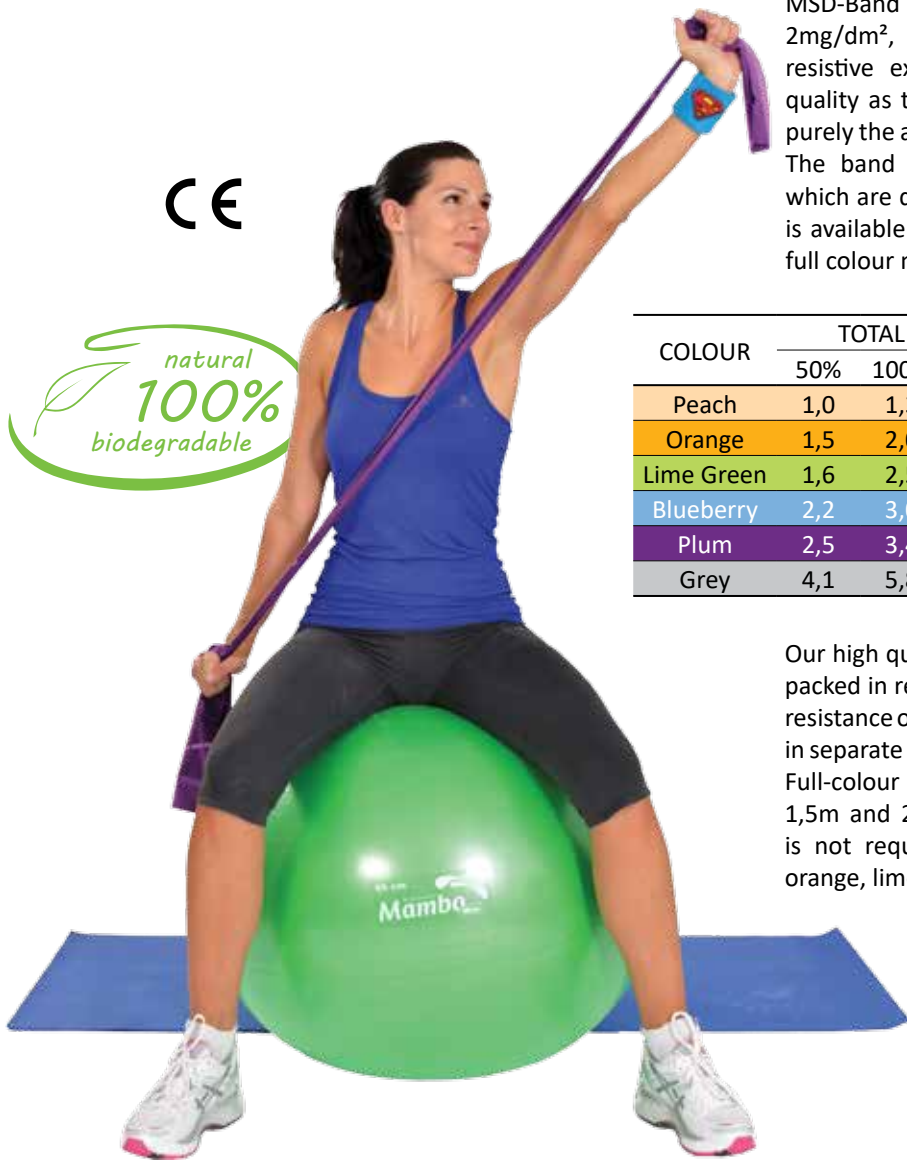

MSD-Band Global is a low powder (in fact, less than 2mg/dm², so we're officially powder-free) latex resistive exercise band with the same premium quality as the original MSD-Band. The difference is purely the alternative, more trendy colour sequence. The band comes in 6 different resistance levels which are determined by the thickness of the band, is available in 4 different lengths and comes with a full colour manual.

COLOUR	TOTAL KG / ELONGATION %					Compares to STANDARD
	50%	100%	150%	200%	250%	
Peach	1,0	1,3	1,5	1,9	2,3	Yellow
Orange	1,5	2,0	2,5	3,2	3,7	Red
Lime Green	1,6	2,5	3,0	3,5	4,1	Green
Blueberry	2,2	3,0	3,6	4,4	5,2	Blue
Plum	2,5	3,4	4,0	4,9	6,1	Black
Grey	4,1	5,8	7,2	7,9	9,5	Silver

Our high quality 1,5m and 2,5m MSD-Band Global is packed in retail packs. 10 pre-cut pieces of the same resistance or 5 pieces of different resistance that come in separate polybags with header for easy dispensing. Full-colour instruction manual is included. These 1,5m and 2,5m bands are easy to use and cutting is not required. The available colours are peach, orange, lime green, blueberry, plum and grey.

Extended Range

COLOUR	RESISTANCE	MSD-BAND GLOBAL				
		5ft / 1,5m	8ft / 2,5m	6yd / 5,5m	25yd / 22,5m	50yd / 45,5m
Peach	Level 1	01-111502	01-110202	01-110502	n/a	01-114502
Orange	Level 2	01-111503	01-110203	01-110503	n/a	01-114503
Lime Green	Level 3	01-111504	01-110204	01-110504	n/a	01-114504
Blueberry	Level 4	01-111505	01-110205	01-110505	n/a	01-114505
Plum	Level 5	01-111506	01-110206	01-110506	n/a	01-114506
Grey	Level 6	01-111507	01-110207	01-110507	01-112207	
Set of 5 resistances (peach to plum)		01-111511	01-110211	n/a	n/a	n/a

Snap-Stop[®]

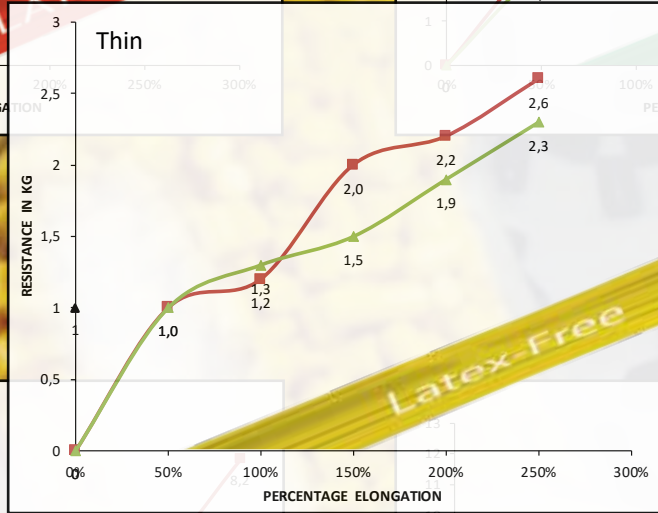
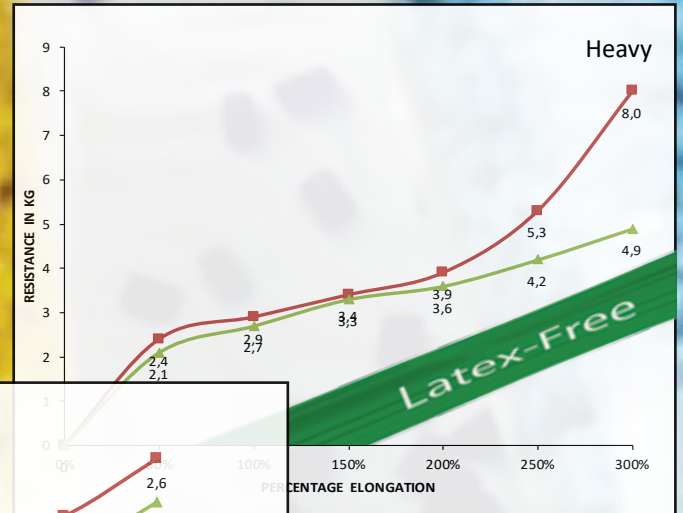
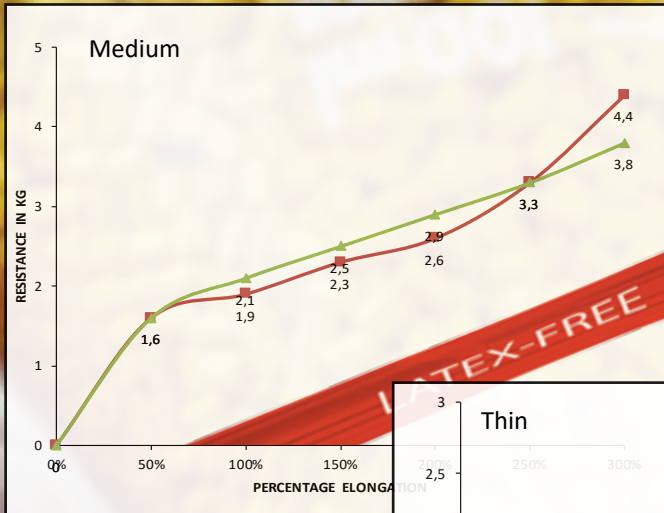

▲ MSD-Band Latex-Free
■ Market Leader

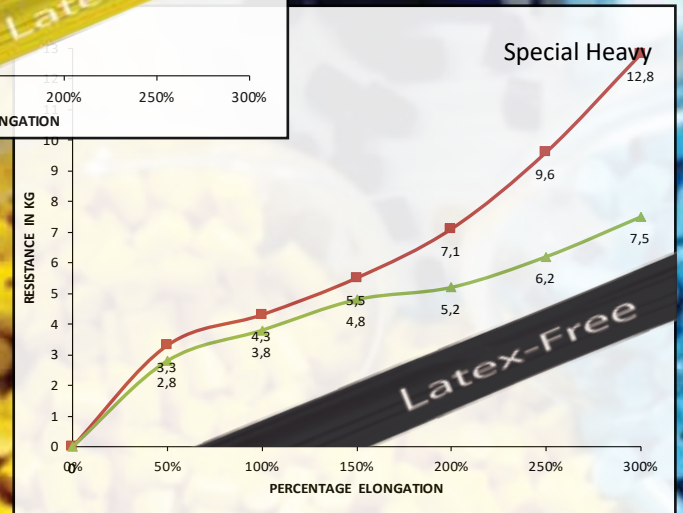
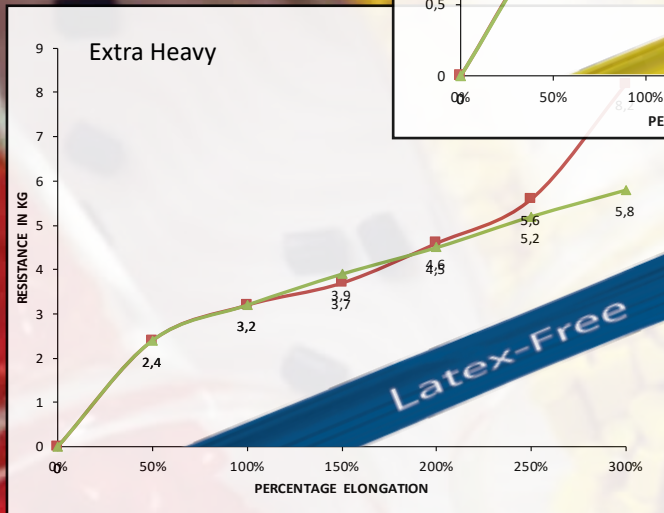

We are confident that MSD-Band Latex-Free is one of the best latex-free resistive exercise bands on the market. The elasticity and linearity are simply amazing. Finally people who don't support latex can exercise with the same high quality specifications. MSD-Band Latex-Free starts from high quality thermoplastic elastomer (TPE), so it's non-toxic and completely PVC and phthalate free.

The linearity from how the strength per elongation evolves is one of the most important specifications as it offers the possibility to apply a very extended range of exercises without risking an injury due to strange product behaviour. Latex-free alternatives will reach their 'elastic stop' more quickly; this is the point where the band feels like a regular string.

We noticed a growing demand and trend for latex free products. For instance, more and more hospitals and centers aim to be completely latex free to avoid possible allergic reactions and issues for their patients. After extensive research and development, we were able to launch our MSD-Band Latex-Free. A product which we're extremely proud of.

LATEX-FREE

MSD-BAND

RESISTIVE EXERCISE SYSTEM

Thanks to our technological leadership, we achieved a Latex-Free exercise band with characteristics that were never before so close to its latex counterpart. With an exceptional 'resistance vs. elongation' linearity, we are confident our MSD-Band Latex-Free Resistive Exercise Band is the best product to fulfil your needs.

The 5 different resistance levels are determined by the thickness of the band. These bands are available in 3 lengths and come with a full colour manual.

- 1,5m: 10 pre-cut pieces of the same resistance or 5 pieces of different resistance (yellow, red, green, blue and black) that come in separate polybags with header.
- 5,5m: A small roll of our premium MSD-Band Latex-Free.
- 45,5m: A big roll of our premium MSD-Band Latex-Free.



COLOUR	TOTAL KG / ELONGATION %				
	50%	100%	150%	200%	250%
Yellow	1,4	1,9	2,2	2,5	2,8
Red	1,6	2,1	2,5	2,9	3,3
Green	2,1	2,7	3,3	3,6	4,2
Blue	2,4	3,2	3,9	4,5	5,2
Black	2,8	3,8	4,8	5,2	6,2

TPE
phthalate-free



COLOUR	RESISTANCE	MSD-BAND LATEX-FREE		
		1,5m	5,5m	45,5m
Yellow	Thin	01-121502	01-120502	01-124502
Red	Medium	01-121503	01-120503	01-124503
Green	Heavy	01-121504	01-120504	01-124504
Blue	Extra Heavy	01-121505	01-120505	01-124505
Black	Special Heavy	01-121506	01-120506	01-124506
Set of 5 resistances (yellow to black)		01-121511	n/a	n/a

LATEX-FREE

The Original

MSD-BAND

RESISTIVE EXERCISE SYSTEM



To answer the continuously growing demand for an universal colour, we do provide our dipped, high quality MSD-Band Resistive Exercise Tubing in a different colour sequence too. These 'Global' colours are derived from the original colours, but will be applied globally as a product on its own, next to the 'Original' colours. You will find the advantages of dipped tubing on p15.

MSD-Band Global Resistive Exercise Tubing is ready to use, straight out of its polybag in a 120cm length with handles. It's also available in 30m rolls, packed in a great dispenser box. Rotation or Safety Handles offer an unlimited amount of exercises and superior grip.

As we constantly continue to develop our products, we present the amazing resistances in the table below. They are available in 6 different resistances.

COLOUR	TOTAL KG / ELONGATION %					Compares to STANDARD
	50%	100%	150%	200%	250%	
Peach	1,0	1,5	1,9	2,3	2,9	Yellow
Orange	1,4	2,0	2,5	2,8	3,4	Red
Lime Green	2,4	3,4	4,0	4,9	5,5	Green
Blueberry	2,9	3,9	4,7	5,6	5,9	Blue
Plum	3,4	4,4	5,4	6,2	7,1	Black
Grey	4,0	5,4	6,5	7,7	8,1	Silver



COLOUR	RESISTANCE	48" / 120cm in polybag	100ft / 30m roll
Peach	Level 1	01-210102	01-213002
Orange	Level 2	01-210103	01-213003
Lime Green	Level 3	01-210104	01-213004
Blueberry	Level 4	01-210105	01-213005
Plum	Level 5	01-210106	01-213006
Grey	Level 6	01-210107	01-213007



The Original

MSD-BAND

RESISTIVE EXERCISE SYSTEM

The MSD-Band Resistive Exercise Tubing is a high quality tubing created by an intensive dipping process. The dipping process guarantees a multi-layered tubing, which ensures a strong and safe training product, while extruded tubings are very susceptible to damage and can easily snap. In general, dipped tubings are even more durable than bands, especially when using it on a coarse surface.

The MSD-Band Tubing is available in 7,5m and 30m rolls that are packed in a great dispenser box. In combination with rotation or safety handles, you get an unlimited amount of exercises and superior grip.

The table below shows the exceptional strength to elongation linearity from our tubing.

COLOUR	TOTAL KG / ELONGATION %					
	50%	100%	150%	200%	250%	300%
Yellow	1,0	1,5	1,9	2,3	2,9	3,6
Red	1,4	2,0	2,5	2,8	3,4	4,0
Green	2,4	3,4	4,0	4,9	5,5	6,5
Blue	2,9	3,9	4,7	5,6	5,9	7,4
Black	3,4	4,4	5,4	6,2	7,1	8,1
Silver	4,0	5,4	6,5	7,7	8,1	9,5



Use our Rotation Handles (p17) for an unlimited amount of exercises or Safety Handles (p22) for superior grip.

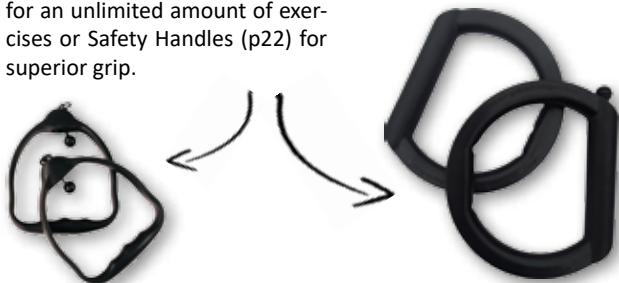

COLOUR	RESISTANCE	MSD-BAND TUBING	
		30m roll	7,5m roll
Yellow	Thin	01-203002	01-200702
Red	Medium	01-203003	01-200703
Green	Heavy	01-203004	01-200704
Blue	Extra Heavy	01-203005	01-200705
Black	Special Heavy	01-203006	01-200706
Silver	Super Heavy	01-203007	01-200707



MSD-BAND O-RING TUBE LOOP

Ideal for abdomen, bottom, hip and leg exercises. With the MSD-Band O-Ring Tube Loop you get an intensive training of each muscular group.

Available in: yellow, red, green, blue and black.



*DIPPED!
not extruded*



MSD-BAND FIGURE 8-RING TUBE LOOP

For intensive training of isolated muscles. Efficient for all muscles of upper- and lower body. The centre of the MSD-Band Figure 8-Ring Tube Loop offers lots of possibilities for short and long pull exercises.

Available in: yellow, red, green, blue and black.

*DIPPED!
not extruded*



MSD-BAND CUFF-RING TUBE LOOP*

The MSD-Band Cuff-Ring Tube Loop is a versatile exercise tool to tone and strengthen all the muscles of the lower body. With velcro closure that fits most sizes.

Available in: yellow, red, green, blue and black.

* This product is not available in Germany.



*DIPPED!
not extruded*



COLOUR	RESISTANCE	O-RING TUBE LOOP	FIGURE 8-RING TUBE LOOP	CUFF-RING TUBE LOOP
Yellow	Thin	01-200202	01-200302	01-200402
Red	Medium	01-200203	01-200303	01-200403
Green	Heavy	01-200204	01-200304	01-200404
Blue	Extra Heavy	01-200205	01-200305	01-200405
Black	Special Heavy	01-200206	01-200306	01-200406

The Serious Strong Rotation Handle is much more than any other handle. It can be used in 3 different positions - stirrup, vertical and channel grip - and the rotational movement gives an additional range of motion. The ball lock grips virtually any exercise tubing or band and allows adjustability in resistance.

The 3 different grip options give 30% more muscle activity. These handles are perfect for a large amount of wrist, elbow and shoulder exercises for both physiotherapy as fitness training. The unique rotational movement enables even more exercises and allows you to easily increase or decrease the preload from the resistive exercise band or tubing even more.



NEW



Reference	Description	Unit	* tubing not included
01-300105	Serious Strong Rotation Handles*	pair	

MSD-BAND TUBING WITH HANDLES

A very useful tool for physiotherapy and muscle training is our dipped MSD-Band Tubing with Handles (120cm). These high quality and very resistant tubes are created to train all muscles in your body and improve body flexibility. The lighter resistances are perfect for physiotherapy or a light work-out, while the highest resistances will even convince the more trained athlete. The MSD-Band Tubing with Handles include a set of handles attached to a quality resistive tubing of 120cm in a polybag with header.

*DIPPED!
not extruded*

They are also available in 2 sets: the Light set includes 3 tubings of 120cm (1x Yellow, 1x Red, 1x Green) while the Heavy set contains 2 tubings of 120cm (1x Blue, 1x Black). Both come with a pair of easily interchangeable handles which can endure huge forces and are packed in a full colour cardboard packaging with butterfly hole for optimal presentation.

Separate:

- 1x Tubing 120cm of choice
- Fix handles in polybag with header.

Light Set:

- 1x Tubing Yellow + 1x Tubing Red + 1x Tubing Green
- + 1 pair of interchangeable handles.

Heavy Set:

- 1x Tubing Blue + 1x Tubing Black
- + 1 pair of interchangeable handles.

Separate



Light / Heavy Set

COLOUR	RESISTANCE	TUBING WITH HANDLES 120CM	MSD-BAND TUBING WITH HANDLES (SET)
Yellow	Thin	01-200102	Light: 01-200111
Red	Medium	01-200103	
Green	Heavy	01-200104	
Blue	Extra Heavy	01-200105	Heavy: 01-200112
Black	Special Heavy	01-200106	
Silver	Super Heavy	01-200107	n/a





With Stoppers

CE

The MSD-Band Shoulder Rope Pulley comes with a pulley, door anchor, nylon cord, stopper system, and detachable hand supports. These hand supports allow patients without gripping power to use the shoulder pulley.

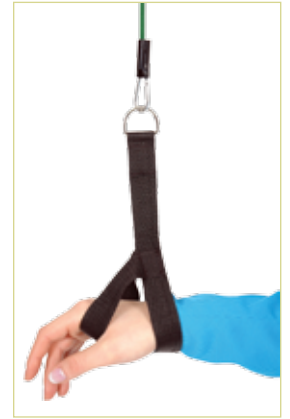

Reference	Description	Unit
01-400103	MSD-Band Shoulder Rope Pulley Hand Support	1 pc



CE

With Stoppers

This MSD-Band Shoulder Rope Pulley comes with a pulley, wooden handles, nylon cord, stopper system, and metal bracket.



Reference	Description	Unit
01-400102	MSD-Band Shoulder Rope Pulley Metal Bracket	1 pc



For rehab use only

Just like the MSD-Band Shoulder Rope Pulley, the MSD-Band Shoulder Tube Pulley helps increase range of shoulder motion. It can be used for prevention and rehabilitation of shoulder injuries.

Due to its resistive tubing, the MSD-Band Shoulder Tube Pulley can also be used for strength development.

The MSD-Band Shoulder Tube Pulley has a light, medium or heavy tubing.

Each pack contains the selected resistance of tubing, soft handles, pulley and door anchor.

CE

Improved

COLOUR	RESISTANCE	SHOULDER TUBE PULLEY
Yellow	Thin	01-400202
Red	Medium	01-400203
Green	Heavy	01-400204



The MSD-Band Shoulder Rope Pulley is an economical, easy-to-use device that helps increase range of shoulder motion. It can be used for prevention and rehabilitation of shoulder injuries. This easy to use shoulder rope pulley can be mounted in a doorway. It is available with notch handles or wooden handles.

The unique notch handles allow the user to easily adjust the length of the rope through the handle while the revolutionary stopper system is a great aid for consistent and progressive exercising.

The MSD-Band Shoulder Rope Pulley comes in a blister pack with a pulley, notch or wooden handles, stopper system, nylon cord and door anchor. The ECO PACK is packed in a polybag, without stoppers.



Reference	Description	Unit
01-400101	MSD-Band Shoulder Rope Pulley Door Anchor Notch Handles Stoppers	1 pc
01-400104	MSD-Band Shoulder Rope Pulley Door Anchor ECO PACK (notch handles, polybag, no stoppers)	1 pc
01-400105	MSD-Band Shoulder Rope Pulley Door Anchor Wooden Handles Stoppers	1 pc

MSD-BAND KNEE ROPE PULLEY

The MSD-Band Knee Rope Pulley helps increase range of knee motion. This easy-to-use product can be mounted in a doorway to help you recover from or prevent knee injuries.

While sitting on a chair, put your foot into the ankle strap. A rope starts from the ankle strap, goes through a pulley and ends at a wooden handle designed for a 2-handed grip. Pull your foot carefully upwards by moving the handle towards your abdomen which will generate a rotational movement at your knee.

The rope length can easily be adjusted at the handle while a print on the ankle strap helps you to secure your foot in the right position. The MSD-Band Knee Rope Pulley comes in a full colour cardboard packaging with a pulley, wooden 2-handed handle, ankle strap, nylon cord and door anchor.

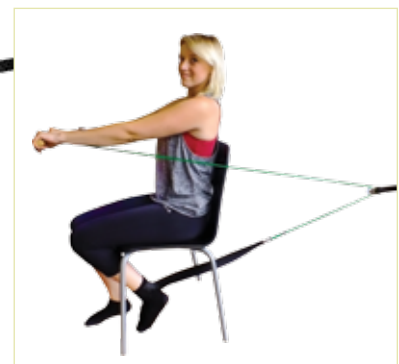

Reference	Description	Unit
01-400301	MSD-Band Knee Rope Pulley Door Anchor 2-handed Wooden Handle	1 pc



RESISTIVE EXERCISE
HAND EXERCISE
UPPER & LOWER BODY EXERCISE
WELLNESS
FITNESS
STRENGTH
THERMAL TREATMENT
MEASUREMENT INSTRUMENTS



Multi-Layered



The MSD-Band Loop is a portable and versatile product. This "Gym on the Go" is a very effective instrument for stretching and strengthening all muscle groups.

Our Loops are multi-layered, this results in a more durable product. These thicker loops won't roll-up during exercising, avoiding the uncomfortable feeling from similar products.

Cost effective and easy to use!



COLOUR	RESISTANCE	UNIT	MSD-BAND LOOP Ø28cm
Yellow	Thin	10 pcs	01-100002
Red	Medium	10 pcs	01-100003
Green	Heavy	10 pcs	01-100004
Blue	Extra Heavy	10 pcs	01-100005



MSD-BAND GLOBAL LOOP



COLOUR	RESISTANCE	UNIT	MSD-BAND GLOBAL LOOP Ø28cm
Peach	Thin	10 pcs	01-110002
Orange	Medium	10 pcs	01-110003
Lime Green	Heavy	10 pcs	01-110004
Blueberry	Extra Heavy	10 pcs	01-110005



Multi-Layered

The MSD-Band Global Loop is easy to use and perfect for stretching and strengthening all muscle groups. The same high quality as the regular MSD-Band Loops, but in a different colour sequence.

Multi-layered loops are more durable and won't roll-up during exercising, therefore, avoiding the uncomfortable feeling from similar products.



With the MSD-Band Global Superloop, you can easily stretch and strengthen different muscle groups. It can be used for rehabilitation and for fitness purposes. The MSD-Band Superloop is 104cm long (circumference is 208cm) and has an incredible elasticity.

The MSD-Band Superloops are multi-layered, this results in a more durable product. These thicker loops won't roll-up during exercising, avoiding the uncomfortable feeling from similar products. They are available in 5 different resistances: Peach, Orange, Lime Green, Blueberry and Plum.



COLOUR	SIZE IN MM	TOTAL KG / ELONGATION %				
		100%	200%	300%	400%	500%
Peach	1040 x 15 x 3,0	7,3	10,0	14,4	19,1	29,2
Orange	1040 x 22 x 4,0	13,0	20,7	27,1	35,0	66,3
Lime Green	1040 x 30 x 4,4	22,5	33,0	44,0	56,2	97,0
Blueberry	1040 x 40 x 4,4	25,6	40,0	53,0	76,0	132,0
Plum	1040 x 53 x 4,4	38,0	56,0	79,0	105,0	167,0

Unlimited exercises?
Go to p22 and discover the
MSD-Band Superloop Wall Mount



Multi-Layered



COLOUR	RESISTANCE	MSD-BAND GLOBAL SUPERLOOP
Peach	Level 1	01-110402
Orange	Level 2	01-110403
Lime Green	Level 3	01-110404
Blueberry	Level 4	01-110405
Plum	Level 5	01-110406

Reference	Description	Unit
01-300001	MSD-Band Superloop Wall Mount	1 pc



Door Anchor



Plug & Play



MSD-Band Superloop Wall Mount



Universal Assist



Serius Strong Rotation Handles

Soft Handles



Safety Handles



Reference	Description	Unit
01-300001	MSD-Band Superloop Wall Mount (Plug & Play)	1 pc
01-300101	MSD-Band Safety Handles	pair
01-300102	MSD-Band Soft Handles	pair
01-300103	MSD-Band Door Anchor	1 pc
01-300104	MSD-Band Universal Assist	1 pc
01-300105	MSD-Band Rotation Handles	pair



The MSD-Band Bar is the ideal product to treat and resolve the golfer's and tennis elbow. This affective product is developed to focus on hand, arm and shoulder problems, this product allows flexion and extension exercises, adduction and abduction exercises and even soft tissue mobilisation, far more than the twisting and bending you would imagine. The MSD-Band Bar is available in 5 colours /resistances: light, medium, heavy, extra heavy and special heavy.

Size: 31cm x 4,5cm
 Packaging: polybag with full-colour header
 Material: dried natural rubber

1 size Ø; 5 Colours / Resistances



*Ideal for
 Golfer's &
 Tennis Elbow
 treatment*



COLOUR	RESISTANCE	MSD-BAND BAR
Yellow	Light	01-600102
Red	Medium	01-600103
Green	Heavy	01-600104
Blue	Extra Heavy	01-600105
Black	Special Heavy	01-600106

MSD-BAND ANKLECISER

The MSD-Band Ankleciser is a great ankle exerciser, complying to all the rigorous quality standards MSD Europe demands of its MSD-Band brand products. It's as easy in use as it's effective. The feet slip comfortably into the latex free elastic band which consists of two stitched loops. Available in 4 different resistances, this progressive exercise system enables the user to choose the desired resistance level to perform the exercises, ranging from rehab to athlete.

Available in a set of 4 resistances, or in a 5-pack of the same resistance.

Packed in a polybag with full-colour header and exercise chart.



COLOUR	RESISTANCE	MSD-BAND ANKLECISER
Yellow	Light	01-500102
Red	Medium	01-500103
Green	Heavy	01-500104
Blue	Extra Heavy	01-500105
Set of 4 resistances		01-500111

The Manus Wrist Exerciser is an adjustable wrist and forearm trainer which allows the user to exercise with progressive resistance. Its ergonomically designed forearm support keeps the wrist in the right place. Together with the soft handgrip, adjustable to 4 positions, it ensures maximum comfort while rehabilitating your wrist and forearm.



Reference	Description	Unit
02-070201	Manus Wrist Exerciser	1 pc



RESISTIVE EXERCISE
HAND EXERCISE
UPPER & LOWER BODY EXERCISE
WELLNESS
FITNESS
STRENGTH
THERMAL TREATMENT
MEASUREMENT INSTRUMENTS

The Manus Adjustable Hand Grip comes in two different versions. Whether it is the 5 to 20 kg light version (orange) or the 10 to 40 kg heavy version (grey), you can always adjust the required tension simply by turning the control knob.

Reference	Description	Unit
02-070102	Manus Adjustable Hand Grip - Light	1 pc
02-070104	Manus Adjustable Hand Grip - Heavy	1 pc

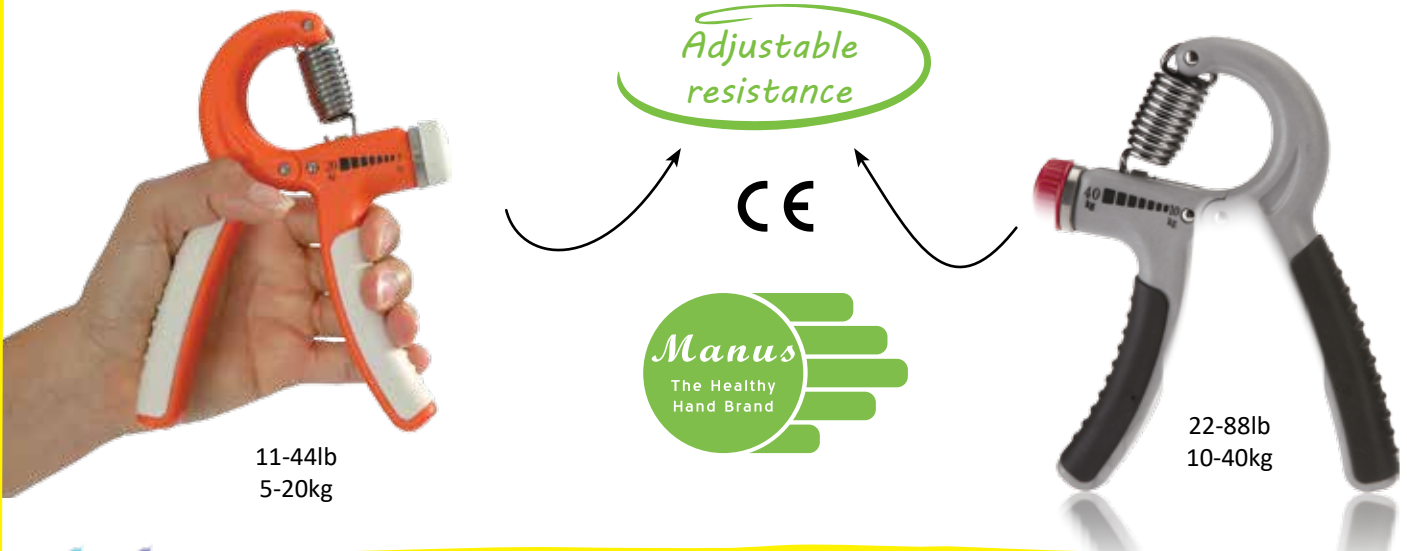

The Mambo Max Foam Hand Grip assures a firm training grip. The foam handles provide a firm grip for the entire workout session. Take it with you to the office or just use it at home. Wherever you want to use it, the Mambo Max Foam Hand Grip assures a tight grasp.

Gripping power = 20kg



Reference	Description	Unit
02-080101	Mambo Max Foam Hand Grip	1 pair



The spring loaded buttons of the Manus Flex-Ion isolate each digit, so the strong fingers cannot compensate for the weaker ones. This results in a better, faster and easier to control rehab process. Manus Flex-Ion is available in 6 colour coded units with gradual resistance. This gradual resistance helps the therapist measure progress. The ergonomic base adds comfort and stability. Comes with a full colour and multilingual instruction manual.

Comes in 6 different colours/resistances and with a 6-level metal display

COLOUR	RESISTANCE (1 digit - all)	Level	Reference	Unit
Tan	0,35kg - 1,10kg	0	02-000101	1 pc
Yellow	0,7kg - 2,3kg	1	02-000102	1 pc
Red	1,4kg - 4,5kg	2	02-000103	1 pc
Green	2,3kg - 7,3kg	3	02-000104	1 pc
Blue	3,2kg - 10,4kg	4	02-000105	1 pc
Black	4,1kg - 14,1kg	5	02-000106	1 pc
Manus Flex-Ion Set 6 Resistances 1 Display			02-000111	set
Manus Flex-Ion Empty Display Metal			02-000121	1 pc

The Digi-Extend® is a unique therapy device that can isolate the extension of all five fingers and each of the individual finger joints. The product strengthens the intrinsic and extrinsic muscle groups to maximize extensor tendon gliding, joint motion, coordination and muscle function in the hand and forearm.

The Digi-Extend® focuses on the extensor mechanism of one or all fingers as it targets the area of the hand that needs rehabilitation. Patients can easily change the resistance levels and vary their hand positions for specific exercises to help maximize the exercise goals and prevent injury. The Digi-Extend® can also be used for finger adduction, abduction, blocking and flexion exercises. It is compact in design, high-tech, easy and comfortable to use as well as effective in helping patients reach their therapy goals. Four colour coded band resistance levels allow each muscle or joint to work at a comfortable level and build as increased strength is achieved.



Reference	Description	Unit
02-010201	Digi-Extend	1 pc
02-010211	Digi-Extend Set 4 units 1 Display	set
02-010202	Digi-Extend Bands Set 25 pcs	set
02-010221	Digi-Extend Empty Display Metal	1 pc

PROHANDS® SERIES



VIA™ is an entry level hand exerciser designed with young athletes in mind. It has a round, soft look, wide finger pistons for smoother function & improved finger performance.

The VIA™ is available in two tensions.



PRO™ provides serious athletes with the most advanced hand exerciser in the world. The PRO™ features a larger profile, superior steel springs that resist wear, an integrated ergonomic palm bar for comfort.

The PRO™ is available in three tensions.

RESISTANCE	VIA	Unit
Light	02-060102	1 pc
Medium	02-060103	1 pc



RESISTANCE	PRO	Unit
Medium	02-060303	1 pc
Heavy	02-060304	1 pc
Extra Heavy	02-060305	1 pc

DIGI-FLEX®

Digi-Flex® develops isolated finger strength, flexibility and coordination. Suitable for rehabilitation after hand injury. The Digi-Flex® comes with an exercise leaflet.

COLOUR	RESISTANCE (1 digit - all)	Reference	Unit
Yellow	0,7kg - 2,3kg	02-010102	1 pc
Red	1,4kg - 4,5kg	02-010103	1 pc
Green	2,3kg - 7,3kg	02-010104	1 pc
Blue	3,2kg - 10,4kg	02-010105	1 pc
Black	4,1kg - 14,1kg	02-010106	1 pc
Digi-Flex Set 5 Resistances 1 Display		02-010111	set
Digi-Flex Empty Display Metal		02-010121	1 pc



RESISTIVE EXERCISE
HAND EXERCISE
UPPER & LOWER BODY EXERCISE
WELLNESS
FITNESS
STRENGTH
THERMAL TREATMENT
MEASUREMENT INSTRUMENTS

COLOUR	RESISTANCE (per digit)	Level	Reference	Unit
X-Light	0,7kg - 1,4kg	1	02-100102	1 pc
Light	1,4kg - 2,3kg	2	02-100103	1 pc
Medium	2,3kg - 3,2kg	3	02-100104	1 pc
Heavy	3,2kg - 4,1kg	4	02-100105	1 pc
X-Heavy	4,1kg - 5,4kg	5	02-100106	1 pc
VariGrip Set 5 Resistances 1 Display			02-100107	set
VariGrip Empty Display Metal			02-100108	1 pc



The VariGrip Therapy is the only exerciser with patented ability to adjust tension in each individual finger. As not all fingers have equal strength, each single finger knob can easily be adjusted. A simple wheel allows you to adjust the resistance for each finger. In addition, resistance can be increased incrementally on the patient's need, which minimises overcompensation and strain. The VariGrip allows the patient to progress steadily between resistance levels.

5 different resistance levels are available. Each VariGrip's highest resistance ends where the next VariGrip resistance starts. Any other hand exerciser increases from Light (1,4kg) to Medium (2,3kg). That's almost a 70% increase gap, which can cause an overload on the muscles, resulting in injuries. The seamless progress from one VariGrip to the other, supported by the padded finger and palm area, guarantees a safe recovery and better feel for those with sensitivity issues.

The VariGrip Therapy comes in 5 different resistances with an attractive retail-friendly packaging. The hands-on design includes informative and multi-lingual instructions.

Comparison Chart: 1 Vari-Grip = 2 Digi-Flex® / Flex-Ion (kg per digit)

VariGrip	X-Light	Light	Medium	Heavy	X-Heavy					
Digi-Flex®	0,7	1,4	1,4	2,3	2,3	3,2	3,2	4,1	4,1	n/a

NEW

CE

Resistance adjustable per finger



RESISTIVE EXERCISE
HAND EXERCISE
UPPER & LOWER BODY EXERCISE
WELLNESS
FITNESS
STRENGTH
THERMAL TREATMENT
MEASUREMENT INSTRUMENTS



The Handmaster Plus™ strengthens the 9 muscles that close the hand as well as the 9 muscles that open the hand. The result is maximum strength, balance and blood flow to the hand, wrist and elbow.



CE

Soft | Purple Ball - Yellow Cord | early rehab
 Medium | Red Ball - Black Cord | late rehab
 Firm | Orange Ball - Grey Cord | strength, speed training

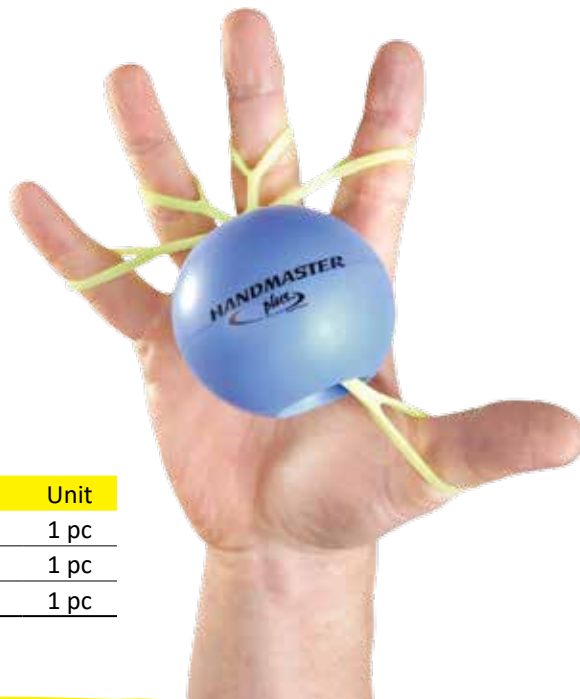

Reference	Description	Unit
02-050102	Handmaster Plus Soft Purple Ball - Yellow Cord	1 pc
02-050103	Handmaster Plus Medium Red Ball - Black Cord	1 pc
02-050104	Handmaster Plus Firm Orange Ball - Grey Cord	1 pc



The creators of the best-selling Power-Web®, are proud to present the original Power-Web® Flex-Grip®. The Power-Web® Flex-Grip® is a unique exerciser that fits in your palm and provides the ability to work dexterity, extension and strengthening in your hands, fingers, and thumbs. Available in 3 different resistances, the Power-Web® Flex-Grip® has finger and thumb holes and has two sides: one side featuring a ball to squeeze and the other featuring buttons and a thumb pad to exercise fingers separately and increase dexterity and strength in your fingers and thumb.

Latex free and easy to use!

The Original

CE



COLOUR	RESISTANCE	POWER-WEB FLEX-GRIP
Yellow	Light	02-021102
Red	Medium	02-021103
Green	Heavy	02-021104



The #1 hand exercise web in the world!



Each Power-Web comes with a 39 exercises poster

The Power-Web® Combo features a unique advantage of two resistance levels in one, offering greater flexibility and value. It is identical in size and weight to the Power-Web® Senior with the same high quality construction and materials.



COLOUR / RESISTANCE		POWER-WEB COMBO
Tan/Ultra Light	Red/Medium	02-020101
Yellow/Light	Green/Heavy	02-020102
Red/Medium	Blue/Super Heavy	02-020103
Green/Heavy	Black/Ultra Heavy	02-020104

POWER-WEB® JUNIOR & SENIOR



Power-Web® Senior

The Power-Web® Senior is 36cm in diameter and weighs 450gr. Its unique patented design allows a variety of exercises to be performed comfortably and effectively. Constructed of high quality rubber with special agents added for durability and strength, the Power-Web® will last for years.



The Original

Power-Web® Junior

The Power-Web® Junior is 18cm in diameter and weighs 225gr. Just half the size of the Power-Web® Senior, it has all the same features as the larger product and delivers many of the same benefits when used in a hand and wrist exercise program.

COLOUR	RESISTANCE	POWER-WEB SENIOR	POWER-WEB JUNIOR
Tan	Ultra Light	02-020201	n/a
Yellow	Light	02-020202	02-020302
Red	Medium	02-020203	02-020303
Green	Heavy	02-020204	02-020304
Blue	Super Heavy	02-020205	n/a
Black	Ultra Heavy	02-020206	n/a



Anti-microbial agents kill bacterium without additives and resist growth of odour-causing microbes. Manus Comfort Putty contains natural anti-microbial without addition of toxic chemicals. This additive ensures the Manus Comfort Putty material retains the clean, non-greasy feel from day one. Cheaper alternatives on the market do not contain these agents. As a small amount of bacteria and other micro-organisms will always be present on the patient's hands and because putty should be stored in room temperature conditions, anti-microbial agents are a must to avoid that the putty becomes the ideal breeding ground for bacteria and fungi. Anti-microbial agents extend the product's lifespan and improves its cleanliness

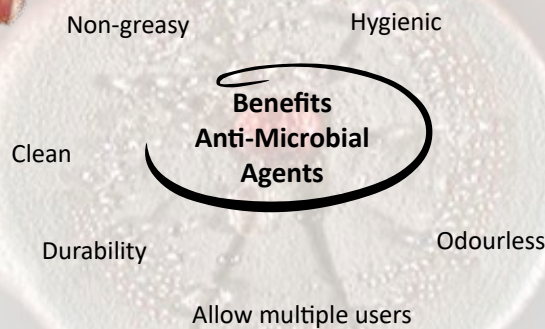

THERAFLEX PUTTY™

With anti-microbial agents

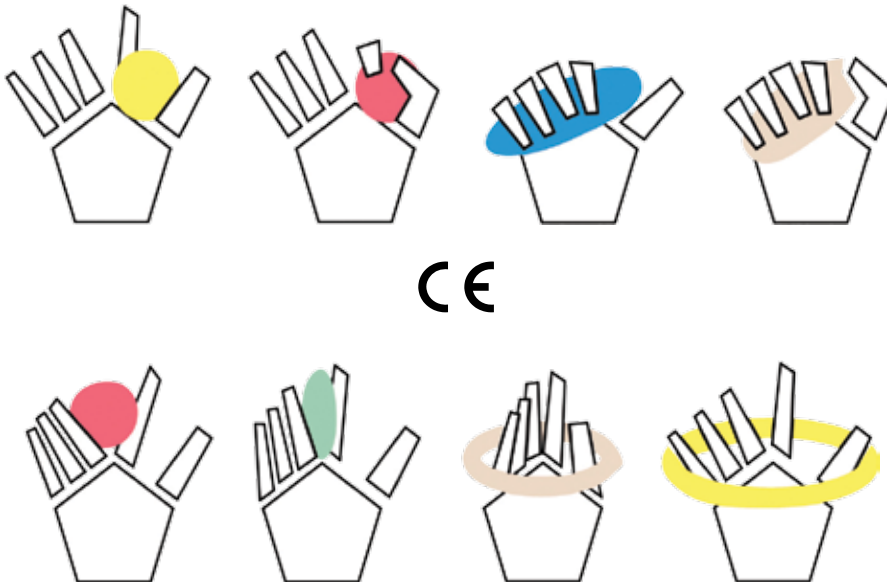

Theraflex Putty™ strengthens weakened grasp through exercise and is used for rehabilitative exercise or stress relief. It is odourless, does not stain and will not leave any residue on the patient's hands. Theraflex Putty™ is non-toxic, greaseless, hypo-allergenic and latex-free. Theraflex Putty™ is available in 5 colours/resistances and comes prepacked.

*NEW
57g & 2,3kg*

COLOUR	RESISTANCE	LEVEL	THERAFLEX PUTTY					
			57g	85g	113g	170g	454g	2,3kg
Tan	Extra Soft	0	02-040001	02-040101	02-040201	02-040301	02-040401	02-040501
Yellow	Soft	1	02-040002	02-040102	02-040202	02-040302	02-040402	02-040502
Red	Medium	2	02-040003	02-040103	02-040203	02-040303	02-040403	02-040503
Green	Firm	3	02-040004	02-040104	02-040204	02-040304	02-040404	02-040504
Blue	Extra Firm	4	02-040005	02-040105	02-040205	02-040305	02-040405	02-040505

FITNESS

STRENGTH

THERMAL TREATMENT

MEASUREMENT INSTRUMENTS



The Manus Comfort Putty does everything a great putty should do: it strengthens weakened grasp through exercise and is used for rehabilitative exercise or stress relief. It is odourless, does not stain and will not leave any residue on the patient's hands. Manus Comfort Putty is non-toxic, greaseless, hypo-allergenic and gluten and latex-free. Manus Comfort Putty is available in 6 colours/resistances and comes pre-packed.



6 different resistances

With anti-microbial agents



COLOUR	RESISTANCE	LEVEL	MANUS COMFORT PUTTY	
			85g	454g
White	Special Soft	-1	02-090101	02-090401
Tan	Extra Soft	0	02-090102	02-090402
Yellow	Soft	1	02-090103	02-090403
Red	Medium	2	02-090104	02-090404
Green	Firm	3	02-090105	02-090405
Blue	Extra Firm	4	02-090106	02-090406

MANUS SQUEEZE BALLS & EGGS



The Manus Squeeze Ball developed to provide a progressive sequence of 5 colors. It strengthens hands, fingers, forearms and will work the muscles separately or in tandem. The Manus Squeeze Ball can be used for rehab as well as for sports training or stress relief.

The Manus Squeeze Egg is ergonomically shaped to provide highly effective exercise for the rehabilitation and strengthening of weakened or injured fingers, hands and wrists. Because it is small and easy to use, you can exercise anywhere, anytime.

Available colors/resistances: yellow, red, green, blue and black.



The Manus Squeeze Balls & Eggs can help to:

- Rehabilitate post-operative/post-traumatic hands and arms,
- Restore function in hands, arms and shoulders following stroke,
- Reduce pain and stiffness in arthritic fingers, hands and wrists,
- Relax tense, sore muscles and reduce stress,
- Strengthen aging hands and arms.



COLOUR	RESISTANCE	LEVEL	SQUEEZE BALL	SQUEEZE EGG
Yellow	Extra Soft	1	02-030102	02-030202
Red	Soft	2	02-030103	02-030203
Green	Medium	3	02-030104	02-030204
Blue	Firm	4	02-030105	02-030205
Black	Extra Firm	5	02-030106	02-030206



RESISTIVE EXERCISE
HAND EXERCISE
UPPER & LOWER BODY EXERCISE
WELLNESS
FITNESS
STRENGTH
THERMAL TREATMENT
MEASUREMENT INSTRUMENTS



- 50x46x38 cm
- 9 kg

The OxyCycle I comes with strap pedals and handgrip pedals.



ACTIVE training only



Reference	Description	Unit
03-010101	OxyCycle I Pedal Exerciser	1 pc

For ACTIVE training only.

The OxyCycle I Pedal Exerciser is used for upper and lower body exercises. The adjustable resistance makes it a great product to progressively strengthen your arms and legs. The OxyCycle I Pedal Exerciser has a light-weight compact design, adjustable resistance and a multi-function LCD display readout scan, time, distance, calories and RPM. A non-skid mat and interchangeable handgrip pedals are included.

OXYCYCLE PEDALS

All these pedals are interchangeable and fit OxyCycle I, II and III.



Reference	Description	Unit
03-020101	Strap Pedals	pair
03-020102	Half-Foot Pedals	pair
03-020103	Full-Foot Pedals	pair
03-020201	Handgrip Pedals	pair

Handgrip Pedal



Strap Pedal



Full-Foot Pedal



Half-Foot Pedal



The OxyCycle II comes with half-foot pedals and handgrip pedals.



PASSIVE training only



- 50x46x38 cm
- 8 kg
- 230V AC
- 50 Hz
- 60 Watt
- 20 - 65 rpm



Reference	Description	Unit
03-010102	OxyCycle II Pedal Exerciser	1 pc

For PASSIVE training only.

The OxyCycle II Pedal Exerciser is a great tool for personalised, low-stress workouts that can be used anywhere. The adjustable speed makes it a great product to progressively strengthen your arms and legs. This pedal exerciser provides low impact exercise to increase strength and flexibility, is versatile for both upper and lower body and it improves the blood circulation. The OxyCycle II Pedal Exerciser has a light-weight compact design, adjustable speed and a multi-function LCD display readout scan, time, count, RPM-level and estimated calories burned. A non-skid mat and interchangeable handgrip pedals are included.



The OxyCycle III comes with full-foot pedals and handgrip pedals.



ACTIVE & PASSIVE training



- 50x46x38 cm
- 8,5 kg
- 230V AC
- 50 Hz
- 60 Watt
- 20 - 65 rpm



Reference	Description	Unit
03-010103	OxyCycle III Pedal Exerciser	1 pc

For ACTIVE and PASSIVE training.

The OxyCycle III Pedal Exerciser is a great tool for personalised, low-stress workouts that can be used anywhere. The adjustable speed and resistance makes it a great product to progressively strengthen your arms and legs. This pedal exerciser provides low impact exercise to increase strength and flexibility, is versatile for both upper and lower body and it improves the blood circulation. The OxyCycle III Pedal Exerciser has a light-weight compact design, adjustable speed & resistance, a 15-minute timer switch and a multi-function LCD display readout scan, time, count, total count and calories burned. A non-skid mat and interchangeable handgrip pedals are included.

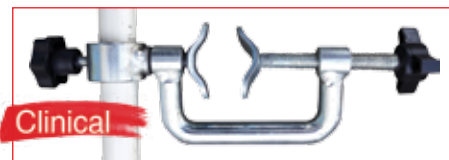

The Saehan Cycles are professional pedal exercisers aimed at rehabilitation. Pedalling improves blood circulation and will increase strength and flexibility after an injury or for elderly.

Both the Home and Clinical Saehan Cycles include attachments to fit the pedal exerciser to a chair or even a wheelchair. The pedal exerciser's length can be perfectly adjusted to the user when his feet are fitted in the pedals with foot straps. A convenient turning knob makes it possible to adjust the resistance (0 - 13 kg) which increases or decreases the effort, resulting in a progressive exercise programme.

The Clinical version from the Saehan Cycle has an even higher level of adjustability. The distance between pedal and crank can be adjusted and the resistance knob indicates the level selected. Together with the convenient grips to attach the Saehan Cycle to a (wheel)chair and different extra accessories, this product will be an essential item in any professional's practice room.

Reference	Description	Unit
03-010301	Saehan Cycle - Home	1 pc
03-010302	Saehan Cycle - Clinical	1 pc



SAEHAN CLINICAL CYCLE ACCESSORIES

Because the Saehan Cycle - Clinical is a product aimed at professionals, we offer various accessories to increase its flexibility and user's safety. Be aware these do only apply to the clinical cycle, not to the home cycle.

For Clinical Cycle Only

Reference	Description	Unit
03-010311	Clinical Cycle Accessory Long front leg	1 pc
03-010312	Clinical Cycle Accessory Extension arm (right = left)	1 pc
03-010313	Clinical Cycle Accessory Hand strap - right	1 pc
03-010314	Clinical Cycle Accessory Hand strap - left	1 pc
03-010315	Clinical Cycle Accessory Long (straight) leg brace set	1 pc
03-010316	Clinical Cycle Accessory Bent leg brace	1 pc



MSD STANDARD PEDAL EXERCISER K/D (KNOCK-DOWN)



The MSD Standard Pedal Exerciser K/D (knock-down) is ideal for restoring impaired muscle strength, improving blood circulation and gives a better coordination to the legs or arms. It can be used on a table top as an arm exerciser or on the floor to give the legs a workout. The MSD Standard Pedal Exerciser K/D is extremely portable and can easily be stored under a chair or bed. Because it only needs 6 screws to be assembled and disassembled, it comes in a very handy and compact box with handle.

The MSD Standard Pedal Exerciser K/D has a convenient tension control knob allowing a broad range of pedal resistance for a progressive exercise programme.

Budget Pack

Pedal straps adjustable to two positions



- 51x41x28 cm
- 2,2 kg



Compact packaging
48x18,5x8,5 cm

Reference	Description	Unit
03-010202	MSD Standard Pedal Exerciser K/D White	1 pc

MSD STANDARD PEDAL EXERCISER



Like the MSD Standard Pedal Exerciser K/D, the pre-assembled MSD Standard Pedal Exerciser is ideal for restoring impaired muscle strength, improving blood circulation and gives a better coordination to the legs or arms. It can be used on a table top as an arm exerciser or on the floor to give the legs a workout. The portable MSD Standard Pedal Exerciser has a convenient tension control knob allowing a broad range of pedal resistance for a progressive exercise programme.

Pedal straps adjustable to two positions



- 52x42x26 cm
- 2 kg



Reference	Description	Unit
03-010201	MSD Standard Pedal Exerciser Chrome	1 pc

RESISTIVE EXERCISE

HAND EXERCISE

UPPER & LOWER BODY EXERCISE

WELLNESS

FITNESS

STRENGTH

THERMAL TREATMENT

MEASUREMENT INSTRUMENTS



EXER I
96 x 45 x 45 (cm) / 11,5 kg
Wall mount included



EXER II
146 x 45 x 54 (cm) / 13,5 kg
Wall mount included



Improvement of blood circulation, muscle strength, joint range of motion and shoulder exercise. The CuraMotion Exer Series has an adjustable resistance and a multi-functional LCD-display readout scan which indicates rotation count, rotations per minute, time exercised and calories consumed. All are easy adjustable with a quick release knob.

Reference	Description	Unit
03-030101	CuraMotion Exer 1	1 pc
03-030102	CuraMotion Exer 2	1 pc
03-030103	CuraMotion Exer 3	1 pc
03-030104	CuraMotion Exer 4	1 pc

EXER III
37 x 38 x 70 (cm) / 9 kg
With foot stands

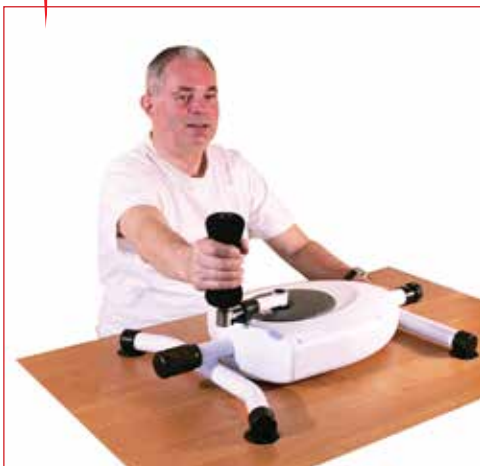

EXER IV
96 x 45 x 45 (cm) / 13 kg
Wall mount included



WOODEN INCLINE BOARD



The incline board increases extension in the lower and upper back while stretching the calves. It can be used:

- to improve the general posture,
- to stretch the calf muscles of athletes, soccer players and sportsperson in general,
- to stretch the upper-leg muscles (Ischias),
- to increase extension in the lower and upper back.



- 50cm x 29,5cm x 3,5cm
- Max. User Weight: 150kg

The MSD Wooden Incline Board - Ladder is made out of natural birch wood and is very resistant. It is adjustable in 4 different angles (10°, 15°, 20° and 25°). After using the MSD Wooden Incline board, it can easily be folded to achieve its compact form when not in use.

The new MSD Wooden Incline Board - Fix is perfect for who's looking for an easy and budget-friendly Incline Board. It's made of polymerised wood for a strong feel and high user weight. The inclination (17,5°) is perfect for physiotherapy exercises.

- 58cm x 30cm x 16cm
- Max. User Weight: 150kg

Reference	Description	Unit
03-040001	MSD Wooden Incline Board - Ladder	1 pc
03-040003	MSD Wooden Incline Board - Fix	1 pc

PLASTIC INCLINE BOARD



Apart from stretching the calf and upper-leg muscles, the incline board is a fantastic device to improve general posture and extension in the lower back.

Made of a composite plastic rated over 250kg. Adjusts to 4 levels and folds flat (8cm) to store easily. Angles are 10°, 15°, 20° and 30°. The last slot on the board makes an excellent hand-hold for stretching. Non-slip top measures 35x35 cm.



Reference	Description	Unit
03-040102	Incline Board Standard	1 pc

Foldable Legs

The Mambo Max Jumping Fitness Trampoline is equipped with bungee cords and a handlebar. Bungee cords protect and support joints and ligaments by providing a deeper and gentler bounce. This allows the muscles to work more, and for a longer period of time, burning calories efficiently without placing unnecessary strain on the body.

Similar to our complete range of trampolines, the Mambo Max Jumping Trampoline helps to flush the lymphatic system, where most toxins are stored. Rebounding also provides an ideal balance of gravity and weightlessness to stimulate the organs and work major and minor muscles in the body. It also serves other core functions, from digestion to mental health.

Finally, bungee trampolines tend to be quieter, sturdier and more reliable than spring trampolines, making upkeep and maintenance a breeze.

Ø 106cm / ↓ 32cm
 ↓ 74-109cm (handrail height from mat)
 200kg

Ready to use

Reference	Description	Unit
03-111102	Mambo Max Jumping Fitness Trampoline	1 pc

HEALTH BOUNCE POD™ *

The Health Bounce Pod™ is the only device on the market able to provide a safe and suitable environment for elderly and injured people to exercise. It is robust, balanced, adjustable, and comfortable. It has been designed by professional trampoline athletes in cooperation with doctors specialised in the field of extreme trauma and accidents.

The adjustable C-hoop, connected to the steel frame by 4 symmetrically placed springs makes it friendly to use by blind people, who can exercise freely and up to their own capability. No other form of exercise can be so easily available with true benefits, with the extra bonus of being fun!

Ø trampoline 96cm / Ø C-Hoop: 58cm
 ↓ mat: 26cm
 ↓ C-hoop: 50-80cm
 (C-hoop height from mat)
 120kg

Reference	Description	Unit
03-110202	Health Bounce Pod™	1 pc

*Product cannot be sold in the UK.



The MSD Rehab Trampoline is the offspring from the passion and dedication from MSD Europe and Active Fun. MSD Europe relies on the extensive know-how and testing results from Active Fun to offer a well-balanced trampoline, made from high-quality materials to achieve the price/quality ratio MSD Europe is known for.

This trampoline is developed starting from a strong and stable base. The high quality tapered springs will give you a very comfortable feeling while bouncing is gentle on joints and ligaments. The durable mat with centre marking will make it easier to locate the centre so both legs are equally trained. Because the removable handlebar is adjustable in 6 positions, it is the perfect companion for any (rehabilitating) patient. The soft and thick padding covers the spring to give the whole product a nice and finished look.

- ∅ 96cm
- ∓ 26cm
- ∓ 68-114cm (handrail height from mat)
- 📖 110kg

Reference	Description	Unit
03-110101	MSD Rehab Trampoline Simple	1 pc
03-110102	MSD Rehab Trampoline Armed (handlebar incl.)	1 pc
03-110110	Handlebar set for MSD Rehab Trampoline	1 pc



The Mambo Max Fit Stretch is a fantastic, simple and portable way to stretch your lower leg muscles. It is perfect for warm-ups and cool-downs. The use of a Mambo Max Fit Stretch helps increase your ankle, shin and calf flexibility. It is made of a durable, moulded plastic and includes a non-skid foot pad.

Reference	Description	Unit
03-050101	Mambo Max Fit Stretch Single Leg	1 pc

MAMBO MAX WOODEN FIT STRETCH

The Mambo Max Wooden Fit Stretch is as fantastic, simple and portable as the regular Mambo Max Fit Stretch. As it's made out of natural birch wood, it's an ecologic and sustainable way to stretch your lower leg muscles. Use it for warm-ups and cool-downs to minimise injuries. You will notice your ankle, shin and calf flexibility will significantly improve after using the Mambo Max Wooden Fit Stretch regularly.



Reference	Description	Unit
03-050001	Mambo Max Wooden Fit Stretch Single Leg	1 pc

MAMBO MAX STANDARD CUSHION

cb m p



Junior

The Mambo Max Standard Cushions, junior and senior, are air-filled cushions for active and dynamic sitting, recommended by therapists. These easy-to-carry air cushions are suitable for everybody, but have different diameters.

Junior: Needle pump included.
Senior: Faster Blaster pump included.

The PVC surface of the Mambo Max Standard Cushions cleans easily with soap and water.



Junior	Senior
Ø 33cm	Ø 37,5cm
↓ 7cm	↓ 7cm

200kg



one smooth | one senso side



Reference	Description	Unit
04-020101	Mambo Max Standard Cushion Junior + Needle Pump	1 pc
04-020103	Mambo Max Standard Cushion Senior + Faster Blaster Pump	1 pc

MAMBO MAX SITTING WEDGE

cb m p



The wedge shape encourages a proper posture and alignment while sitting at a desk or table. It is an inflatable, dynamic cushion that activates intrinsic trunk muscles to support the spine. The Mambo Max Sitting Wedge can be used as a back support. Faster blaster pump included.

The PVC surface of the Mambo Max Sitting Wedge cleans easily with soap and water.



□ 34cm
↓ 7cm
250kg



one smooth | one senso side

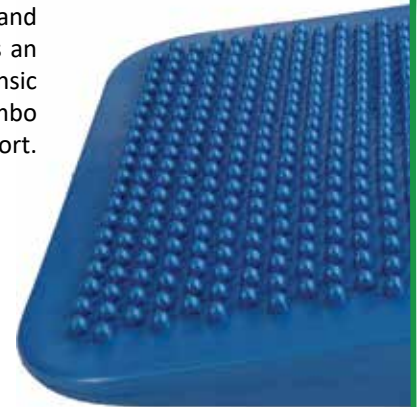

Reference	Description	Unit
04-020201	Mambo Max Sitting Wedge + Faster Blaster Pump	1 pc

MAMBO MAX SENS AIR CUSHION

cb m p



The Mambo Max SensAir Cushion is an air-filled cushion for active and dynamic sitting recommended by therapists. This easy-to-carry air cushion is suitable for everybody. Needle pump included.

The PVC surface of the Mambo Max SensAir Cushion cleans easily with soap and water.



Ø 32cm
↓ 7cm
200kg



one smooth | one senso side



Reference	Description	Unit
04-020102	Mambo Max SensAir Cushion + Needle Pump	1 pc

RESISTIVE EXERCISE

HAND EXERCISE

UPPER & LOWER BODY EXERCISE

WELLNESS

FITNESS

STRENGTH

THERMAL TREATMENT

MEASUREMENT INSTRUMENTS



The Mambo Max Soft-Over-Ball is available as a 26 (blue) or 18cm (green) inflatable ball used for resistance work in Pilates. It is a wonderful tool for adding focus and energy to your workouts. In addition, when slightly deflated it can be used as a soft prop under the head, neck, feet, back,...

Ø 18 - 26cm
100 kg

Reference	Description	Unit
04-010103	Mambo Max Pilates Soft-Over-Ball - Blue - 26cm	1 pc
04-010105	Mambo Max Pilates Soft-Over-Ball - Green - 18cm	1 pc



Reference	Description	Unit
04-010102	Mambo Max Pilates Foam Roller - EVA 90cm	1 pc
04-010104	Mambo Max Pilates Foam Roller - EVA 45cm	1 pc
04-010106	Mambo Max Pilates Foam Roller - EPE 90cm	1 pc

The Mambo Max Foam Roller has been designed for Pilates training and spine exercises (back aches). Ideal for balance and stabilisation exercises. Foam rollers are used for stretch and strength exercises, as well as for massage and relaxation. Available in EVA and EPE.

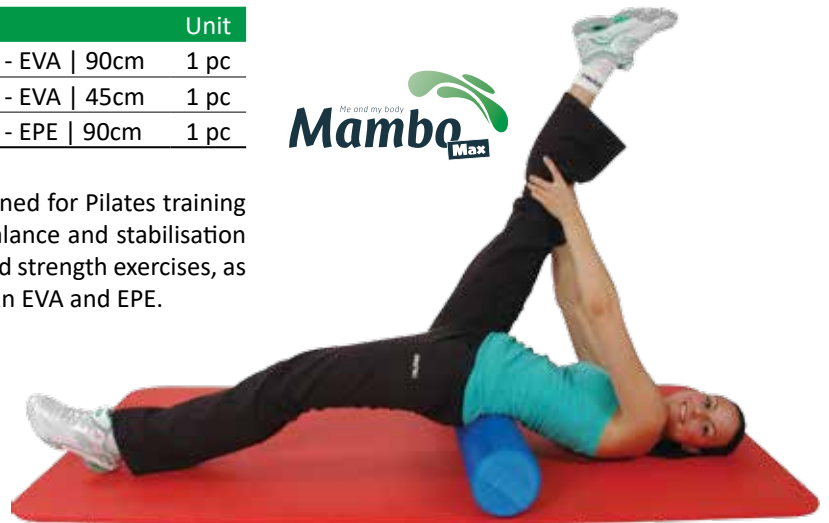

Foam covered fiberglass resistive exercise ring with foam padded grips. For exercises focusing on strength, balance, flexibility and posture. The Mambo Max Pilates Ring adds light resistance to pilates exercises and helps target specific muscle groups. Often used to help tone the arms and thighs, and increase the core strength challenge of an exercise.

Ø 38 cm

Reference	Description	Unit
04-010101	Mambo Max Pilates Ring	1 pc





Massage rollers are used to put pressure on the muscles' triggerpoints and to loosen the tension in the muscles. Trigger points are often the cause of different pains.

Ø 14cm
↔ 33cm



The Mambo Max Hollow Foam Roller can easily help people who are experiencing long term pains. Its three dimensional pattern with different shapes replicates the massage from a therapist's hands. The larger surfaces allow a superficial massage while the smaller shapes are designed for a deeper massage.



Ø 15cm
↔ 33cm

The Mambo Max Ergonomic Foam Roller is a curved hollow foam roller, which enables more exercises. Except rolling back and forth, it's possible to make sideways movements. More muscles will be addressed through which the body will be toned even more. The soft foam in combination with the nipples is perfect for trigger point massages. The central groove will reduce pressure on the spine.

NEW

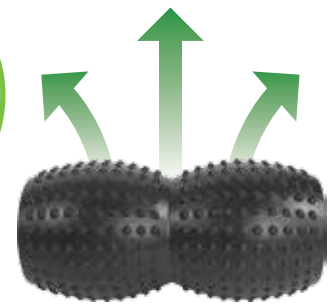

NEW



Ø 15cm
↔ 46cm

Ø 10cm
↔ 46cm

Ø 4cm
↔ 46cm

NEW

The Mambo Max 3-in-1 foam roller combines 3 different foam rollers in one package. Thanks to its smooth surface, the outer part is perfect for a superficial massage. The second part has grooves which can be used for a deeper massage and to exercise higher pressure on the trigger points. Finally, with the inner massage stick it's possible to exercise high pressure on sore muscles to improve blood circulation and the muscles' recovery time. This last item is available as a separate product too: The Mambo Max Massage Stick.



Reference	Description	Unit
04-050101	Mambo Max Hollow Foam Roller	1 pc
04-050102	Mambo Max Ergonomic Foam Roller	1 pc
04-050301	Mambo Max 3-in-1 Foam Roller	1 set
04-050201	Mambo Max Massage Stick	1 pc

This yoga set consists of:

- 1 pvc yoga mat (173 x 61 x 0,4 cm),
- 2 EVA foam yoga blocks (7,5 x 15 x 23 cm)
- 1 yoga strap with buckle (180 x 3,8 cm)

This set is packed in a full colour box. Items are also sold separately.



Reference	Description	Unit
04-010201	Mambo Max Yoga Mat	1 pc
04-010202	Mambo Max Yoga Block	5-pack
04-010203	Mambo Max Yoga Strap	1 pc
04-010211	Mambo Max Yoga Set 1 Mat 2 Blocks 1 Strap	Set



MAMBO MAX STEPPING STONE

The non-slip 16 cm Mambo Max Stepping Stone is an amazing tool to spice up your workout. It is also good for children's (group) exercises, both indoors and outdoors. Combine balance training and motor skill development increase, with playing. It is also used for foot massage, while sitting.

📏 100 kg



Reference	Description	Unit
04-030141	Mambo Max Stepping Stone	6-pack

MAMBO MAX MASSAGE BALL, ROLL & RING

The Mambo Max Massage Balls, Roll & Ring are used for relaxing muscles and reducing tension by relieving trigger points. The Mambo Max Massage Ball helps to strengthen hands and feet and to improve coordination and flexibility. It can be used for massage therapy as well as to improve dexterity skills.

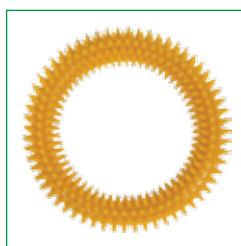
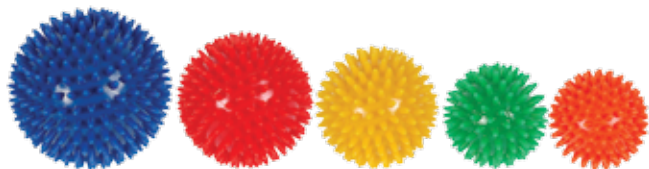

Reference	Description	Unit
04-030103	Massage Ball 6 cm	1 pc
04-030105	Massage Ball 7 cm	1 pc
04-030107	Massage Ball 8 cm	1 pc
04-030109	Massage Ball 9 cm	1 pc
04-030111	Massage Ball 10 cm	1 pc
04-030121	Massage Roll 16 cm	1 pc
04-030131	Massage Ring	1 pc

MASSAGE TOOLS



Jacknobber® II
The Original Index Knobber® II allows deep, sustained and precise pressure to the trigger points. It is used for sore and stiff muscles. The special design protects the hand and forearm from fatigue and overuse.



Palmassager™
The Original Palmassager™ is frequently used to massage tensed, tired and sore muscles. It is used for back, shoulder, arms and legs.

The Originals



Index Knobber® II
The Original Index Knobber® II allows deep, sustained and precise pressure to the trigger points. It is used for sore and stiff muscles. The special design protects the hand and forearm from fatigue and overuse.



Backnobber® II
The Original Backnobber® II allows the user to apply as much pain-releasing pressure as long as required to achieve remarkable effects. A locking mechanism allows it to come apart for convenient travel and storage.

Reference	Description	Unit
04-031101	Jacknobber II	1 pc
04-031102	Index Knobber II	1 pc

Reference	Description	Unit
04-031103	Palmassager	1 pc
04-031104	Backnobber II	1 pc

RESISTIVE EXERCISE

HAND EXERCISE

UPPER & LOWER BODY EXERCISE

WELLNESS

FITNESS

STRENGTH

THERMAL TREATMENT

MEASUREMENT INSTRUMENTS

Your clients
and your hands
deserve the best
possible care

The NAQI New Generation of innovative massage
lotions that provide the best skin-friendly treatment.

You and Your Clients will Feel the NAQI Difference.

- Excellent Lubrication
- Structure similar to the skin
- Prolonged hydration
- Same pH as the skin
- Rinses off with water
- Economical usage
- Hypo allergen perfume

A wide range of
massage and sports lotions
available on www.naqi.com



naqi.com



Non greasy,
leaves skin
soft and dry

Gives smooth,
light skin
feel



Sales@naqi.com

www.naqi.com

NAQI[®]
SKIN IN
BALANCE

Belgian Skin Care Expertise NAQI® nv/sa, Stadsbeemd 1037, BE-3545 Halen Belgium - T : +32 13 460 190 F : +32 13 460 199 - sales@naqi.com

FITNESS

STRENGTH

THERMAL
TREATMENT

MEASUREMENT
INSTRUMENTS

BALL ACCESSORIES



Hand Pump Profi



Faster Blaster Pump



Foot Pump



Needle Pump



Ball Stacker
with velcro
closure



The Ball Stabiliser facilitates balance. Its notches enable combined AB Gym Ball / MSD-Band exercises.

Ball Stabiliser

Reference	Description	Unit
05-020101	Ball Stabiliser	1 pc
05-020102	Ball Stacker	3 pcs
05-020201	Faster Blaster Pump 2x 120mm	1 pc
05-020202	Hand Pump Profi 2x 2000mm	1 pc
05-020203	Needle Pump 8" - 100mm	1 pc
05-020204	Foot Pump	1 pc

MAMBO MAX AB GYM BALL



Ecofriendly pvc - Heavy metal content in compliance with EN 71 Standards - Phthalates content meets EU-directive 2005/84/EC.



ANTI-BURST

350 kg
Yes, 350 kg!!!



The Mambo Max AB (Anti-Burst) Gym Ball increases flexibility, improves strength, fitness and posture. Exercising with this ball also enhances your balance and coordination. All AB Gym Ball, the Peanut Ball is Anti-Burst too. In case the ball gets punctured by a sharp object the ball won't burst, thus reducing risk of injury.

This extremely durable Mambo Max AB Gym Ball comes in a Mambo Max cardboard retail pack, including AB Gym Ball, Faster Blaster Pump, Exercise Chart, Plug and Plug Remover.

The Mambo Max AB Gym Ball is now also available in the budget pack: a polybag containing only the ball and plug.

Budget Pack

Ball Size	Colour	Body Height	Mambo Max AB Gym Ball Box + Hand pump	Mambo Max AB Gym Ball Bag in polybag	Unit
45cm	Yellow	< 125 cm	05-010102	n/a	1 pc
55cm	Red	125-150 cm	05-010103	05-010203	1 pc
65cm	Green	150-175 cm	05-010104	05-010204	1 pc
75cm	Blue	175-185 cm	05-010105	05-010205	1 pc
85cm	Black	185-200 cm	05-010106	n/a	1 pc
95cm	Silver	> 200 cm	05-010107	n/a	1 pc

MAMBO MAX AB PEANUT BALL



NEW

ANTI-BURST

This new addition in our AB (Anti-Burst) Gym ball range helps users who struggle with the instability of a regular gym ball. The peanut shape offers extra sideways stability, which gives more confidence to start working out with Gym Balls. The Mambo Max AB Peanut Ball offers a more predictable therapy or fitness training as it can only roll in one direction. This certainly is a huge benefit for children, elderly or people who suffered an injury. In addition, Peanut Balls are very popular amongst pregnant women and are very helpful devices during labour.

Similar to our regular Mambo Max AB Gym Ball, the Peanut Ball is Anti-Burst. In case the ball gets punctured by a sharp object the ball won't burst, thus reducing risk of injury.

The Mambo Max AB Peanut Ball comes in a Mambo Max cardboard retail pack, including Faster Blaster Pump and Plug.

Peanut Ball Size	Colour	Mambo Max AB Peanut Ball + Faster Blaster Pump	Unit
50 x 100cm	Red	05-011103	1 pc

RESISTIVE
EXERCISE

HAND
EXERCISE

UPPER & LOWER
BODY EXERCISE

WELLNESS

FITNESS

STRENGTH

THERMAL
TREATMENT

MEASUREMENT
INSTRUMENTS

The Mambo Max Exercise Mats provide a soft touch and comfortable exercise environment. They are perfect for gym & fitness. Non-slip, well-cushioned surface with a unique closed cell structure. The mats are equipped with plastic rings so they can be suspended while not in use. Each mat comes with a handy storage/carry strap.



May be used in water

The Mambo Max Mat Hanger holds up to 10 mats. Distance between bars is 40cm.

Reference	Description	Unit
05-030001	Exercise Mat Wall Hanger for 10 mats	1 pc
05-030101	Exercise Mat 1,5 x 60 x 185 (cm) Red Rings Strap	1 pc
05-030102	Exercise Mat 1,5 x 60 x 185 (cm) Green Rings Strap	1 pc
05-030103	Exercise Mat 1,5 x 60 x 185 (cm) Blue Rings Strap	1 pc
05-030201	Exercise Mat 1,5 x 100 x 185 (cm) Red Rings Strap	1 pc
05-030202	Exercise Mat 1,5 x 100 x 185 (cm) Green Rings Strap	1 pc
05-030203	Exercise Mat 1,5 x 100 x 185 (cm) Blue Rings Strap	1 pc



MAMBO MAX BODY TWISTER

The Mambo Max Body Twister is your ideal partner to slim your thighs, waist and hips. While twisting your body, the disc below your feet turns and glutes, abdominals and legs are being trained. Continue to twist your body from side to side to tone all muscles in your body. The Mambo Max Body Twister is also an effective product to enhance balance and coordination.



Ø 25cm
 ⌀ 3cm
 100kg

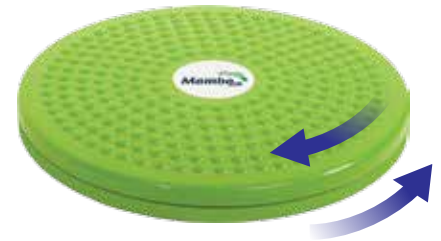

Reference	Description	Unit
05-100101	Mambo Max Body Twister	1 pc

MAMBO MAX AEROBIC STEP



Step aerobics is a form of aerobics that is practised worldwide by millions of people. The reason for its popularity is simple, it offers a great cardio workout without the need for extensive space or equipment. While the aim of aerobics is to increase the body's consumption of oxygen, step aerobics builds on that goal by offering a more intense workout. The Mambo Max Aerobic Step provides this extra boost by incorporating the action of stepping onto the platform to intensify the workout. It is low impact, and doesn't stress the joints as much as running or jogging.

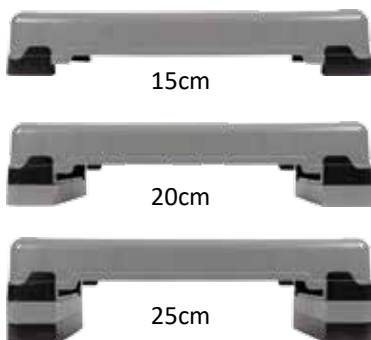

96cm x 33cm
 ⌀ 15-20-25cm
 100kg

Reference	Description	Unit
05-070101	Mambo Max Aerobic Step	1 pc



Half sphere, inflatable exercise dome. This versatile product enables the user to perform exercises on both sides of the product, allowing it to be used for a full body work-out as well as for balance exercises. Basically it's Mambo Max' economical answer to the BOSU® system, but with extra tubing and handles!



∅ 59cm
 ∓ 21-25cm
 175 kg

Packed in a full colour box.

Improved



Faster Blaster Pump included



Reference	Description	Unit
05-040401	Mambo Max Dynadome Tubing with handles	1 pc

MAMBO MAX WOODEN WORK-OUT STATION



With the Mambo Max Wooden Work-Out Station an even higher amount of exercises are suddenly available. The cleverly spread rings allow you to attach a resistive exercise band or tubing for various vertical and diagonal exercises.

The Work-Out Station is designed to fit an Aerobic Step or a set of Oval Balance Pad. This mix of various products results in a complete and challenging workout. Combining balance with resistive exercise triggers many different muscles in your body. The Mambo Max Wooden Work-Out Station truly offers a complete and three dimensional workout.

Outer Dimension: 103 x 40 (cm)
 Inner Dimension: 96 x 33 (cm)



Reference	Description	Unit
05-110001	Mambo Max Wooden Work-Out Station	1 pc

RESISTIVE EXERCISE

HAND EXERCISE

UPPER & LOWER BODY EXERCISE

WELLNESS

FITNESS

STRENGTH

THERMAL TREATMENT

MEASUREMENT INSTRUMENTS



MAMBO MAX EKILIBRE BEGINNER

The Mambo Max Balance Plate "Ekilibre" is designed for balance training. Combining balance pad with balance board, it offers the best of both worlds. It improves your sense of equilibrium, coordination, reaction and motor skills. It can be used for lying, kneeling, sitting and stepping movement and it can be incorporated with other exercise equipment to spice up your rehabilitation. Designed for rehab & therapy home use.



Reference	Description	Unit
05-040501	Mambo Max Ekilibre Beginner *	1 pc



□ 60cm x 39cm
 ↓ 9cm
 ⚖️ 100kg



MAMBO MAX EKILIBRE INTERMEDIATE



Reference	Description	Unit
05-040502	Mambo Max Ekilibre Intermediate *	1 pc

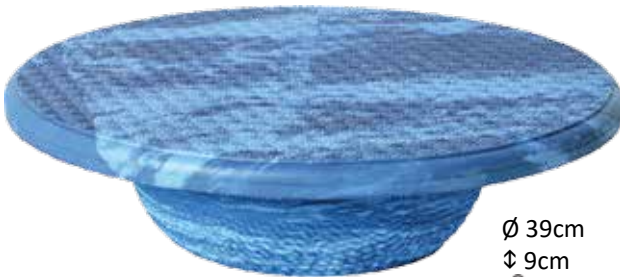

∅ 39cm
 ↓ 9cm
 ⚖️ 100kg



MAMBO MAX EKILIBRE ADVANCED



Reference	Description	Unit
05-040503	Mambo Max Ekilibre Advanced *	1 pc



□ 60cm x 39cm
 ↓ 12cm
 ⚖️ 100kg



* Can not be sold in Canada.

RESISTIVE
EXERCISE

HAND
EXERCISE

UPPER & LOWER
BODY EXERCISE

WELLNESS

FITNESS

STRENGTH

THERMAL
TREATMENT

MEASUREMENT
INSTRUMENTS

MAMBO MAX BALANCE TRAINER



Reference	Description	Unit
05-040102	Mambo Max Balance Trainer 45 cm	1 pc
05-040103	Mambo Max Balance Trainer 60 cm	1 pc

The Mambo Max Balance Trainer is designed for balance training. Use it to improve your sense of equilibrium, coordination, reaction and motor skills. It is also ideal for muscle exercise. The Mambo Max Balance Trainer can be adjusted by inflating and deflating the air through the valve. It can be used for lying, kneeling, sitting and stepping movement and it can be incorporated with other exercise equipment to spice up your rehabilitation.

Inflate your Mambo Max Balance Trainer with the pumps on p43

Ø 45cm
 ↓ 16cm
 100kg



Ø 60cm
 ↓ 14cm
 100kg



RESISTIVE EXERCISE

HAND EXERCISE

UPPER & LOWER BODY EXERCISE

MAMBO MAX BALANCE BOARD



Reference	Description	Unit
05-040201	Mambo Max Balance Board	1 pc

The Mambo Max Balance Board is an effective tool for balance training and rehabilitation exercise. Stand on the rounded platform and start balancing. It is also a great tool to strengthen your ankles and thigh muscles. For a more severe balance training, add the included screw-on top to your Mambo Max Balance Board.

Ø 42cm
 ↓ 5-8cm
 100kg



WELLNESS

FITNESS

MAMBO MAX BALANCE BOARD FREEMAN



Reference	Description	Unit
05-040202	Mambo Max Balance Board Freeman	1 pc

The Mambo Max Balance Board Freeman is an effective tool for balance training and rehabilitation exercise. Stand on the rounded platform and start balancing. This is a great tool to strengthen your ankles and thigh muscles. The handgrips on the bottom are used for upper body balancing and workouts.



Ø 40cm
 ↓ 8cm
 100kg



STRENGTH

THERMAL TREATMENT

MEASUREMENT INSTRUMENTS

MEDICA®

Hall 4
-
Stand D21

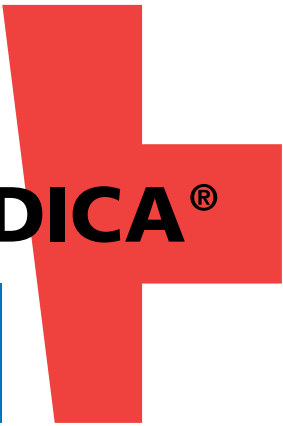

*New Booth Number
Same Spot*



Hall 7 - Stand A12

115.000 square-metres of floor space and 5.000 exhibitors from 70 countries, 17 exhibition halls, 5 conferences, 6 forums, several special stands and one visitor at the centre of attention: You!

MEDICA - the world's largest medical trade fair - covers the entire spectrum of exhibits for both ambulant and in-patient treatment.

All relevant information is available on www.medica.de.

The Arab Health Exhibition & Congress is the largest healthcare exhibition & medical congress in the Middle East. Second largest in the world.

The 2016 exhibition showcased more than 4,000 companies exhibiting their latest innovations to more than 130,000 healthcare professionals attending from 163 countries.

Thanks to 138.000 visitors and 725 exhibitors, FIBO is the worldwide Leading Trade Fair for Fitness, Wellness and Health.

Every year in April, global top decision makers of the industry come together in Cologne looking for the latest innovations and trends for their gyms, wellness facilities, doctors and physiotherapy practises, etc...

For more information please visit www.fibo.de.

MEDICA

Düsseldorf - Germany
13 - 16 November 2017

ARAB HEALTH

Dubai - UAE
30 Jan. - 2 Feb. 2018

FIBO

Cologne - Germany
12 - 15 April 2018

MSD Europe will attend Medica, FIBO and Arab Health in 2016 - 2017. MSD North America will be present at FIME and both Medtrade shows. It will be our pleasure to welcome you at our booths.

MEDTRADE

Atlanta - USA
23 - 25 October 2017

MEDTRADE

Las Vegas - USA
28 - 29 March 2018

FIME

Orlando - USA
17 - 19 July 2018

Medtrade is the largest Home Medical Equipment Expo and Conference in the US. Connecting the HME industry for 35 years, Medtrade features a large expo floor filled with the leading home medical equipment manufacturers and their DME products. At Medtrade you can find everything from the basics to the latest innovations in mobility, respiratory, sleep, rehab, and aids to daily living.

See www.medtrade.com for more information.

Medtrade is the largest Home Medical Equipment Expo and Conference in the US. Connecting the HME industry for 35 years, Medtrade features a large expo floor filled with the leading home medical equipment manufacturers and their DME products. At Medtrade you can find everything from the basics to the latest innovations in mobility, respiratory, sleep, rehab, and aids to daily living.

See www.medtrade.com for more information.

The largest international medical trade fair & congress in the world's biggest medical market. The sole purpose is to provide you with the largest selection of medical products available anywhere at any time. FIME is the number one exhibition for medical dealers, distributors and medical professionals seeking the latest supplies, equipment and products from all over the world.

Check www.fimeshow.com for all the details.



MAMBO MAX BALANCE PAD



This foam balance pad provides the comfortable exercise environment needed to perform reinforcing balance exercises. Its soft and thus unstable surface challenges the user to work the foot-, ankle-, and leg muscles.

Available in three versions:

- 1 rectangular chamfered shaped pad, 47 x 39 x 6 (cm), blue
- 1 rectangular chamfered shaped pad, 47 x 39 x 6 (cm), anthracite
- 2 oval shaped pads, 37 x 22 x 6 (cm) - sold per pair



Reference	Description	Unit
05-040301	Mambo Max Balance Pad Rectangular Blue	1 pc
05-040303	Mambo Max Balance Pad Rectangular Anthracite	1 pc
05-040302	Mambo Max Balance Pad Oval Blue	pair

MAMBO MAX WOODEN BALANCE BOARDS



Uni: □ 40cm x 40cm / ↓ 10cm
Max. user weight: 150kg



Rehab: □ 40cm x 40cm / ↓ 6cm
Max inclination: 12,5°
Max. user weight: 150kg



Sport: Ø 40cm / ↓ 9cm
Max inclination: 20°
Max. user weight: 150kg



Reference	Description	Unit
05-040001	Mambo Max Wooden Balance Board - Rehab	1 pc
05-040002	Mambo Max Wooden Balance Board - Sport	1 pc
05-040003	Mambo Max Wooden Balance Board - Uni-directional	1 pc

The Mambo Max Wooden Balance Board is your perfect partner if you want to improve your balance on an ecologic and high-end product. The Wooden Balance board is available in 3 versions: Uni-Directional, Rehab & Sport. Their different form and balance point make it possible to have 3 products with a very different character and level of difficulty.

Children and elderly could experience a balance board with pivot point as too challenging. The Uni-directional Balance Board offers more confidence. This enables the user to improve body stability without the fear of falling.

A Uni-directional Balance Board offers a more predictable therapy or fitness training as it can only pivot in one direction. When turning the Balance board upside-down, the arches can be used as push-up grips. Once the user is ready for the next level of training, the Balance Board Rehab or Sport are ideal next steps in the process.

The Balance Board Rehab is lower than the Balance Board Sport. In addition with its smoother pivot point, it reacts completely different than the Sport. It's a great middle step between the Balance Board Uni-Directional and Balance Board Sport.

The most challenging Balance Board is our Sport version, which, as the name specifies, makes it a real sport. Finding your balance and avoiding the edges to touch the ground is hard and requires you to use all your muscles in your body. It's a great and fun way to exercise a full-body workout.



RESISTIVE EXERCISE

HAND EXERCISE

UPPER & LOWER BODY EXERCISE

WELLNESS

FITNESS

STRENGTH

THERMAL TREATMENT

MEASUREMENT INSTRUMENTS

RESISTIVE EXERCISE
HAND EXERCISE
UPPER & LOWER BODY EXERCISE
WELLNESS
FITNESS
STRENGTH
THERMAL TREATMENT
MEASUREMENT INSTRUMENTS



The MSD Rehab Trampoline is the offspring from the passion and dedication from MSD Europe and Active Fun. MSD Europe relies on the extensive know-how and testing results from Active Fun to offer a well balanced trampoline, made from high-quality materials to achieve the well known price/quality ratio of MSD Europe.

This trampoline is developed starting from a strong and stable base. The high quality tapered springs will give you a very comfortable feeling while bouncing is gentle on joints and ligaments. The durable mat with center marking will make it easier to locate the center so both legs are equally trained. Because the removable handlebar is adjustable in 6 positions, it is the perfect companion for any (rehabilitating) patient. The soft and thick padding covers the spring to give the whole product a nice and finished look.

- Ø 96 cm
- ↓ 26 cm
- ↓ 68-114 cm (handrail height from mat)
- 📦 110 kg

Perfect for rebounding



Springs

Reference	Description	Unit
03-110101	MSD Rehab Trampoline Simple	1 pc
03-110102	MSD Rehab Trampoline Armed (handlebar incl.)	1 pc
03-110110	Handlebar set for MSD Rehab Trampoline	1 pc

HEALTH BOUNCE POD™*



The Health Bounce Pod™ is the only device on the market able to provide a safe and suitable environment for elderly and injured people to exercise. It is robust, balanced, adjustable, and comfortable. It has been designed by professional trampoline athletes in cooperation with doctors specialized in the field of extreme trauma and accidents.

The adjustable C-hoop, connected to the steel frame by 4 symmetrically placed springs makes it friendly to use by blind people, who can exercise freely and up to their own capability. No other form of exercise can be so easily available with true benefits, with the extra bonus of being fun!

- Ø trampoline 96 cm / Ø C-Hoop: 58 cm
- ↓ mat: 26 cm
- ↓ C-hoop: 50-80 cm (C-hoop height from mat)
- 📦 120 kg

Reference	Description	Unit
03-110202	Health Bounce Pod™	1 pc

*Product cannot be sold in the UK.

Our brand new Mambo Max Jumping Fitness Trampoline is equipped with bungee cords and a handlebar. Bungee cords protect and support joints and ligaments by providing a deeper and gentler bounce. This allows the muscles to work more, and for a longer period of time, burning calories efficiently without placing unnecessary strain on the body.



Bungee cords

Ready to use

Foldable Legs

Similar to our complete range of trampolines, the Mambo Max Jumping Trampoline helps to flush the lymphatic system, where most toxins are stored. Rebounding also provides an ideal balance of gravity and weightlessness to stimulate the organs and work major and minor muscles in the body. It also serves other core functions, from digestion to mental health.

Finally, bungee trampolines tend to be quieter, sturdier and more reliable than spring trampolines, making upkeep and maintenance a breeze.

Ø 106 cm / † 32 cm
 † 74-109 cm (handrail height from mat)
 200 kg

Reference	Description	Unit
03-111102	Mambo Max Jumping Fitness Trampoline	1 pc

RESISTIVE EXERCISE
 HAND EXERCISE
 UPPER & LOWER BODY EXERCISE
 WELLNESS
 FITNESS
 STRENGTH
 THERMAL TREATMENT
 MEASUREMENT INSTRUMENTS

With the MSD-Band Global Superloop, you can easily stretch and strengthen different muscle groups. It can be used for both rehabilitation and fitness purposes. The MSD-Band Superloop is 104cm long (circumference is 208cm) and has an incredible elasticity.

The MSD-Band Superloop is available in 5 different resistances: peach, orange, lime green, blueberry and plum (specifications on p21). Combine it with our MSD-Band Superloop Wall Mount to achieve an even higher versatility of exercises.



CE

Multi-Layered

COLOUR	RESISTANCE	MSD-BAND GLOBAL SUPERLOOP
Peach	Level 1	01-110402
Orange	Level 2	01-110403
Lime Green	Level 3	01-110404
Blueberry	Level 4	01-110405
Plum	Level 5	01-110406

Reference	Description	Unit
01-300001	MSD-Band Superloop Wall Mount	1 pc



The MSD-Band Global Loop is a portable and versatile product. This "Gym on the Go" is a very effective instrument for stretching and strengthening all muscle groups. Cost effective and easy to use!



CE

Multi-Layered

COLOUR	RESISTANCE	UNIT	MSD-BAND GLOBAL LOOP Ø28cm
Peach	Thin	10 pcs	01-110002
Orange	Medium	10 pcs	01-110003
Lime Green	Heavy	10 pcs	01-110004
Blueberry	Extra Heavy	10 pcs	01-110005

The MSD-Band Bar is the ideal product to treat and resolve golfer's and tennis elbow. This efficient product is developed to focus on hand, arm and shoulder problems, this product allows flexion and extension exercises, adduction and abduction exercises and even soft tissue mobilisation, far more than the twisting and bending you would imagine. The MSD-Band Bar is available in 5 colours/resistances.

Packed in a polybag with full-colour header.
 Ø 4,5 cm / ↔ 31 cm

1 size Ø; 5 Colours / Resistances

Ideal for
 Golfer's &
 Tennis Elbow
 treatment

COLOUR	RESISTANCE	MSD-BAND BAR
Yellow	Light	01-600102
Red	Medium	01-600103
Green	Heavy	01-600104
Blue	Extra Heavy	01-600105
Black	Special Heavy	01-600106



CE

Our MSD-Band Global is a premium quality low powder latex resistive exercise band. The different resistance levels are determined by the thickness of the band. These bands are available in peach, orange, lime green, blueberry, plum and grey.

The 1,5m and 2,5m MSD-Band Global are packed in retail packs. 10 pre-cut pieces of the same resistance or 5 pieces of different resistance that come in separate polybags with header for easy dispensing.

The 5,5m, 22,5m and 45,5m MSD-Band Global are packed on a roll in a full-colour dispenser box. An instruction manual is always included.

For the resistance level of each colour, please see page 11, where you will find the applied force per elongation.



The Original **MSD-BAND**
RESISTIVE EXERCISE SYSTEM



COLOUR	RESISTANCE	8ft / 2,5m	6yd / 5,5m	25yd / 22,5m	50yd / 45,5m
Peach	Level 1	01-110202	01-110502	n/a	01-114502
Orange	Level 2	01-110203	01-110503	n/a	01-114503
Lime Green	Level 3	01-110204	01-110504	n/a	01-114504
Blueberry	Level 4	01-110205	01-110505	n/a	01-114505
Plum	Level 5	01-110206	01-110506	n/a	01-114506
Grey	Level 6	01-110207	01-110507	01-112207	n/a
Set of 5 resistances (peach to plum)		01-110211	n/a	n/a	n/a

MSD-BAND GLOBAL TUBING

The continuously growing demand for a universal colour has led to our high quality MSD-Band Global Resistive Exercise Tubing.

Our high quality MSD-Band Global Resistive Exercise Tubing, ready to use, comes straight out of its polybag in a 120cm length with handles. It is also available in 30m rolls, packed in a great dispenser box. In combination with safety handles, you get a superior grip.

As we constantly continue to develop our products, we present the improved resistances in the table on page 14. They are available in 6 different resistances.



The Original **MSD-BAND**
RESISTIVE EXERCISE SYSTEM



COLOUR	RESISTANCE	48" / 120cm in polybag	100ft / 30m roll
Peach	Level 1	01-210102	01-213002
Orange	Level 2	01-210103	01-213003
Lime Green	Level 3	01-210104	01-213004
Blueberry	Level 4	01-210105	01-213005
Plum	Level 5	01-210106	01-213006
Grey	Level 6	01-210107	01-213007

Use our Rotating Handles (p17) for an unlimited amount of exercises or Safety Handles (p22) for superior grip.

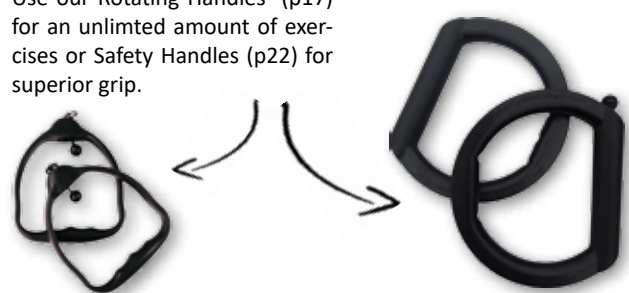

AQUATIC FLOATING BELT



The Aquatic Floating Belt provides added safety during training. It also helps teaching kids to swim. Keeps younger swimmers' head up while learning to swim.

Circumference: 50-113cm



Reference	Description	Unit
05-050303	Aquatic Floating Belt	1 pc

SWIM NOODLE

Noodles can be used as resistance equipment for muscle strengthening or as floating device. They are made of ultra-flexible foam that can bend into any shape. Ideal for aquagym, for fitness exercises and a perfect way to strengthen muscles in the water, especially the abdominals. Also great for relaxation and fun in the pool.

∅ 7cm
↔ 150cm

Reference	Description	Unit
05-050101	Swim Noodle	1 pc



AQUATIC PULL BUOY



The Aquatic Pull Buoy is a figure-eight shaped floating device used in swim workouts. Place the buoy between the legs to provide support to the body without kicking the legs, allowing focus on training only the arms. The Aquatic Pull Buoy is an excellent training device for developing endurance and upper body strength. Good body position and technique can be established and breathing rhythm can be refined. It also provides individuals with heavy legs to be better positioned in the water.

Reference	Description	Unit
05-050601	Aquatic Pull Buoy	1 pc

The Mambo Max Dumbbells are cast iron dumbbells, coated with vinyl or neoprene. The vinyl coating is easy washable or can be treated with a water based disinfectant. The neoprene coating has an added resin to give them a scrubby feel and superior grip.

Available in 7 weights with matching colour code. The Dumbbell Rack holds 6 Dumbbells.



Description	Weight	Vinyl	Neoprene	Unit
Mambo Max Dumbbell	0,5kg	06-010102	06-010202	pair
Mambo Max Dumbbell	1kg	06-010103	06-010203	pair
Mambo Max Dumbbell	1,5kg	06-010104	06-010204	pair
Mambo Max Dumbbell	2kg	06-010105	06-010205	pair
Mambo Max Dumbbell	3kg	06-010107	06-010207	pair
Mambo Max Dumbbell	4kg	06-010108	06-010208	pair
Mambo Max Dumbbell	5kg	06-010109	06-010209	pair
Mambo Max Dumbbell rack	n/a	06-000101		1 pc

MAMBO MAX SOFT DUMBBELL



The Mambo Max Soft Dumbbells are a pair of durable and non-slip steel, fixed weight, foam coated dumbbells. The Soft Dumbbells are extremely suited to add extra strength elements to your aerobic or cardio workout. By using these dumbbells during your exercise session, your muscles strengthen in a natural way. The adjustable hand strap allows fast exercising and jogging. Also suitable for advanced strength and endurance training. The foam surface provides a very comfortable feeling.

Reference	Description	Weight	Unit
06-010302	Mambo Max Soft Dumbbell	0,5kg	pair
06-010303	Mambo Max Soft Dumbbell	1kg	pair



RESISTIVE EXERCISE

HAND EXERCISE

UPPER & LOWER BODY EXERCISE

WELLNESS

FITNESS

STRENGTH

THERMAL TREATMENT

MEASUREMENT INSTRUMENTS



0,5 - 2kg

To quickly build stamina and muscle, simply add Mambo Max Wrist and Ankle Weights to your workout. They are filled with iron sand and will effectively shape and tone your body and can be worn anywhere. Wear them around the office, out shopping or at the gym. Eventually, your body will adjust to running, walking and living with this extra weight.



3 - 5kg

Reference	Description	Weight	Unit
06-020102	Mambo Max Wrist & Ankle Weights	0,5kg	pair
06-020103	Mambo Max Wrist & Ankle Weights	1kg	pair
06-020104	Mambo Max Wrist & Ankle Weights	1,5kg	pair
06-020105	Mambo Max Wrist & Ankle Weights	2kg	pair
06-020107	Mambo Max Wrist & Ankle Weights	3kg	pair
06-020108	Mambo Max Wrist & Ankle Weights	4kg	pair
06-020109	Mambo Max Wrist & Ankle Weights	5kg	pair



The Mambo Max Thumb Lock Wrist Weight enables you to fix the weight to your thumb, ensuring a fixed position during your entire workout. Being it boxing, running or Zumba, the weights will remain in place.

Reference	Description	Weight	Unit
06-020202	Mambo Max Thumb Lock Wrist Weights	0,5kg	pair
06-020203	Mambo Max Thumb Lock Wrist Weights	1kg	pair

MAMBO MAX KETTLEBELL

The Mambo Max Kettlebells are an important part of any fitness or CrossFit training. Made from high quality iron and surrounded with a colourful vinyl coating, they will not damage any surfaces when being stored. Starting from 2 kg up to 24 kg, we also offer you a complete set, including a premium quality Kettlebell Rack, which can hold up to 150kg per shelf (total of 300kg).

Available in: 2 - 4 - 6 - 8 - 10 - 12 - 16 - 20 - 24kg



150cm x 50cm x 70cm (l x w x h)



Reference	Weight	Description	Unit
06-050102	2kg	Mambo Max Kettlebell Sky Blue	1 pc
06-050104	4kg	Mambo Max Kettlebell Pink	1 pc
06-050106	6kg	Mambo Max Kettlebell Yellow	1 pc
06-050108	8kg	Mambo Max Kettlebell Red	1 pc
06-050110	10kg	Mambo Max Kettlebell Green	1 pc
06-050112	12kg	Mambo Max Kettlebell Blue	1 pc
06-050116	16kg	Mambo Max Kettlebell Black	1 pc
06-050120	20kg	Mambo Max Kettlebell Silver	1 pc
06-050124	24kg	Mambo Max Kettlebell Gold	1 pc
06-051001	Mambo Max Kettlebell Rack		1 pc
06-051101	Mambo Max Kettlebell Rack with 1 Kettlebell of each weight		set



RESISTIVE EXERCISE

HAND EXERCISE

UPPER & LOWER BODY EXERCISE

WELLNESS

FITNESS

STRENGTH

THERMAL TREATMENT

MEASUREMENT INSTRUMENTS



A medicine ball (also known as an exercise ball, a med ball, or a fitness ball) is often used for rehabilitation and strength training as it plays an important role in the field of sports medicine. Medicine ball training is one of the oldest forms of strength and conditioning training – the first reference to wrestlers training with sand filled bladders appears in Persia nearly 3000 years ago. In ancient Greece the physician Hippocrates had his patients throw them back and forth for injury prevention and rehabilitation.

Reference	Description	Ø	Unit
06-030103	Mambo Max Medicine Ball - 1kg	20cm	1 pc
06-030104	Mambo Max Medicine Ball - 1,5kg	20cm	1 pc
06-030105	Mambo Max Medicine Ball - 2kg	20cm	1 pc
06-030107	Mambo Max Medicine Ball - 3kg	22cm	1 pc
06-030108	Mambo Max Medicine Ball - 4kg	22cm	1 pc
06-030109	Mambo Max Medicine Ball - 5kg	27cm	1 pc
06-000301	Mambo Max Medicine Ball rack (6 balls)		1 pc



Mambo Max SoftMeds are colour coded hand weighted balls that are small and flexible enough to grasp with one hand, yet big enough to hold with both hands. The soft, pliable vinyl cover makes it easy to hold and is a safe and effective way to add weight training to your workout. Mambo Max SoftMeds are fully inflated and ready to use, straight out-of-the box. When needed, air pressure can be adjusted with a needle pump.



Reference	Weight	Description	Unit
06-040102	0,5kg	Mambo Max SoftMeds Tan	1 pc
06-040103	1kg	Mambo Max SoftMeds Yellow	1 pc
06-040104	1,5kg	Mambo Max SoftMeds Red	1 pc
06-040105	2kg	Mambo Max SoftMeds Green	1 pc
06-040106	2,5kg	Mambo Max SoftMeds Blue	1 pc
06-040107	3kg	Mambo Max SoftMeds Black	1 pc





CE

front

back



The Para Pro is a professional paraffin wax heating bath which is made to be used on 220/230 Volt power sockets and which can be used 24/7. In combination with our premium paraffin pearls it only needs 2,5 hours to completely melt 2,5kg of paraffin. The temperature is adjustable from 40-60°C and is easy to control due to the digital thermometer.

When ordering the Para Pro, you receive 2,5kg of paraffin pearls free of charge.

Para Pro Specifications:

- Outer dimensions: 39cm x 25cm x 18cm (l x w x h)
- Inner dimensions: 32,5cm x 18cm x 13cm (l x w x h)
- Weight: 3,1kg
- 220 V: No transformer needed, which will lengthen the durability.
- Low power consumption once the paraffin has melted
- 24-hours a day fully operational
- Quick melting (+- 2,5 hours)
- Adjustable temperature button (40 - 60°C)
- Digital thermometer

Paraffin Specifications:

- White fully refined paraffin wax, 52/54 DAB
- Congealing point: 53°C
- Meets the purity requirements of BGA¹, Ph.Eur.² and FDA³

1. Bundesgesundheitsamt recommendation No. XXV B II;
 2. European Pharmacopoeia, current edition;
 3. Food and Drug Administration, § 172.886 Petroleum Wax

Paraffin Pearls = Fast melting



Reference	Description	Unit
07-100101	MSD Para Pro + 2,5kg Paraffin Pearls	1 pc
07-110102	Paraffin Pearls - 2,5kg	1 pc
07-110125	Paraffin Pearls - 25kg	1 pc

The MSD Hot/Cold Packs are usable both when treating with heat or cold. This dual applicability makes them a strong alternative to ordinary heating pillows and ice packs. The versatile, reusable packs deliver hot and cold therapy effectively and economically. The use of the MSD Hot/Cold Pack is unlimited and its material is non-toxic. Even below -20°C it remains soft. The MSD Hot/Cold Pack can be bent in any angle, allowing maximum coverage of joint and muscle. All Hot/Cold Packs can be heated in the microwave and can be frozen in the freezer. Temperature holds approximately 30 minutes.

MSD Hot/Cold Pack | Classic - Gel

The classic (and economical) transparent Hot/Cold Pack. The special gel is non-toxic and biodegradable.

MSD Hot/Cold Pack | Standard - Gel

MSD Europe's standard Hot/Cold Pack. Nylon cover gelpack. The special gel is non-toxic and biodegradable.

MSD Hot/Cold Pack | Soft Touch - Clay

The Soft Touch improved and has a frost-free, user friendly surface that allows usage in direct contact with the skin. The Soft Touch is filled with clay, a 100% natural product.



CE

100% polyester protection sleeve for hot/cold packs. Machine washable. Available in 3 sizes.



Dimension		MSD Hot/Cold Packs			Sleeve		Unit
		Classic (gel)	Standard (gel)	Soft Touch (clay)	100% polyester		
15cm x 25cm	Small	07-010102	07-010202	07-010302	07-020102	10 pcs	
20cm x 30cm	Medium	07-010103	07-010203	07-010303	07-020103	10 pcs	
25cm x 35cm	Large	07-010104	07-010204	07-010304	07-020104	10 pcs	
40cm x 20cm	Tri-Sectional	n/a	07-010211	07-010311	n/a	10 pcs	

RESISTIVE EXERCISE | HAND EXERCISE | UPPER & LOWER BODY EXERCISE | WELLNESS | FITNESS | STRENGTH | THERMAL TREATMENT | MEASUREMENT INSTRUMENTS



PearlPacks are reusable Hot/Cold Packs filled with small pearls. Hot and Cold Therapy can be applied to relieve pain and inflammations associated with muscle strain and sprain. This dual applicability makes them a strong alternative to ordinary heating pillows and ice packs. The small pearls absorb heat or cold, which they can retain for 20 minutes. During these 20 minutes, these packs will relieve a part from the pain.



PearlPack Sport Pack

This portable classic pack can be applied on any part of the body.



PearlPack Back Wrap

This large pack divided in 3 segments is equipped with velcro strap. It fits perfectly around the patient's waist for an optimal pain relief on the back. The pearls can be pushed from one segment to the other if one area of the back needs less or more thermal treatment.



PearlPack Eye Mask

This mask adapts to the patient's face, the length from the velcro strap is adjustable. Hot treatment can be applied when eyes feel dry or if there's an infection of the eyelid. Cold treatment will help when suffering from headaches, swollen eyes or sinusitis.

Not only do they look good, the products are very convenient in use. PearlPacks won't feel wet nor drip after freezing or heating them, avoiding a mess. All material used is non-toxic and odourless.

Besides relieving pain from an injury or muscle strain, hot/cold packs are often used to reduce swelling after an operation. PearlPacks truly are multifunctional products.



Reference	Description	Dimension	Unit
07-040101	PearlPack - Sport Pack	19cm x 12,5cm	1 pc
07-040201	PearlPack - Back Wrap	43cm x 17,5cm	1 pc
07-041101	PearlPack - Eye Mask	22,5cm x 7,5cm	1 pc

RESISTIVE EXERCISE
HAND EXERCISE
UPPER & LOWER BODY EXERCISE
WELLNESS
FITNESS
STRENGTH
THERMAL TREATMENT
MEASUREMENT INSTRUMENTS



Torex® Finger Radial
For sprained finger, swollen finger or post-surgery.
One size fits most.



Torex® Large Radial
For sore overworked knees, swollen knee, post knee surgery, torn knee ligaments...
Size: 380 - 540 mm



Torex® Small Radial
For sprained wrist, injured hand, swollen hand, carpal tunnel syndrome, sore upper foot, plantar fasciitis, tennis elbow.
Size: 75 - 250 mm



Torex® XL Radial
For pulled thigh muscle, pulled hamstring, sore upper leg muscle, large knee applications.
Size: 540 - 710 mm



Torex® Medium Radial
For sore foot, swollen foot, plantar fasciitis, tennis elbow, sore elbow.
Size: 250 - 380 mm



Torex® Pro Ankle Boot
A high performance ankle cold and compression brace designed by PRO Athletic Trainers, effectively treats soft-tissue structures damaged in most ankle injuries.

Torex® Roll-on Sleeves are a true 'open-ended tubular shape' which provides 100% coverage and excellent fit over ankles, arches, arms, elbows, fingers, feet, knees, thighs and wrists. The gel filled, one piece radial design allows hot or cold therapy to be delivered to the entire area around your limb in one deep, penetrating application.



Reference	Description	Unit
07-030101	Torex® Hot/Cold Sleeve Finger	1 pc
07-030102	Torex® Hot/Cold Sleeve Small	1 pc
07-030103	Torex® Hot/Cold Sleeve Medium	1 pc
07-030104	Torex® Hot/Cold Sleeve Large	1 pc
07-030105	Torex® Hot/Cold Sleeve Extra Large	1 pc
07-030201	Torex® Hot/Cold Pro Ankle Boot	1 pc

Grip **SAEHAN**®

40 years of experience in
& Exceptional Quality
Amazing Accuracy

PROMO
year



- 1. One-piece aluminum body with internal oil channel.
- 2. Durable wall bellows.
- 3. Accurate double scale gauge.
- 4. Aluminum handle with no perceptible motion.

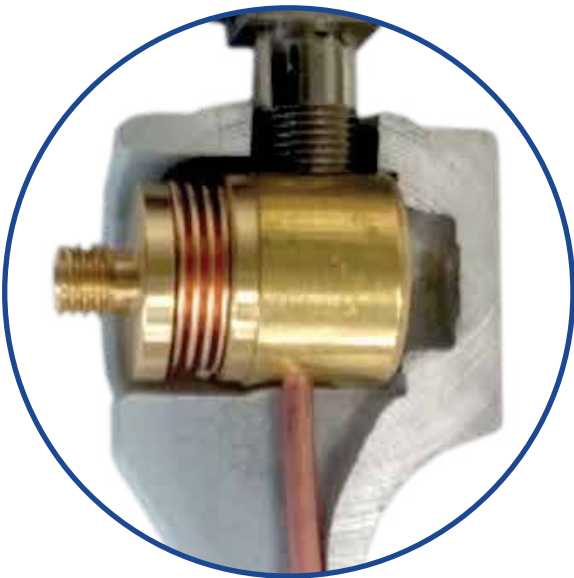

MSD EUROPE
CALIBRATION

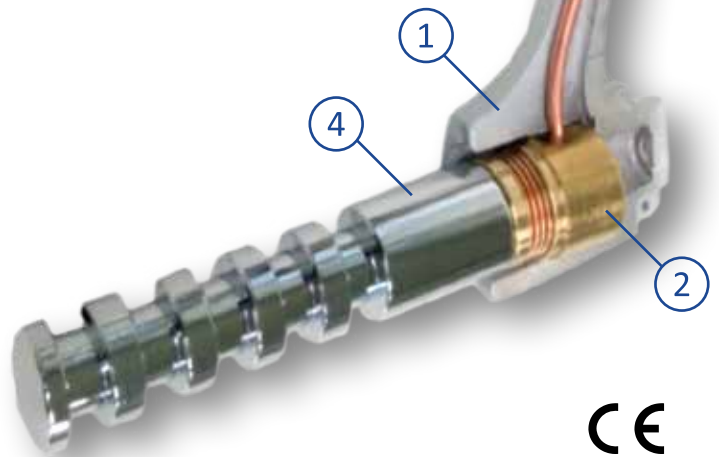

CE

Vast range of quality products



SAEHAN HYDRAULIC 3-PIECE HAND EVALUATION KIT



Portable carrying case contains all instruments necessary to evaluate the strength and range-of-motion of the hand and fingers.

Set includes:

- hydraulic hand dynamometer
- hydraulic pinch gauge
- stainless steel finger goniometer 15cm - 180° per 5°

Quality Hard Case Box

CE Grip SAEHAN®

Reference	Description	Unit
08-010113	Saehan Hydraulic Hand Evaluation Kit 3 pieces	Set

SAEHAN HYDRAULIC 7-PIECE HAND EVALUATION KIT



Portable carrying case contains all instruments necessary to evaluate the strength and range-of-motion of the hand and fingers.

Set includes:

- hydraulic hand dynamometer
- hydraulic pinch gauge
- stainless steel finger goniometer 15cm - 180° per 5°
- 2-point discriminator with 3rd point
- wartenburg pinwheel
- finger circumference gauge
- functional finger motion gauge

Quality Hard Case Box

CE Grip SAEHAN®

Reference	Description	Unit
08-010117	Saehan Hydraulic Hand Evaluation Kit 7 pieces	Set

SAEHAN HYDRAULIC HAND DYNAMOMETER

Reference	Description	Unit
08-010101	Saehan Hydraulic Hand Dynamometer	1 pc



CE

SAEHAN[®]

Quality Hard Case Box



The Hydraulic Hand Dynamometer gives accurate grip strength readings without the subject being able to “feel” the handle move. The adjustable handle has 5 positions to accommodate to any hand size. The indicator remains at the subject’s maximum reading until it is reset. Has a scale in kilograms. Comes in a hard carrying case.

Range: 0 - 90kg (200lb)

SAEHAN DIGITAL HAND DYNAMOMETER - DHD-1

Reference	Description	Unit
08-010201	Saehan Digital Hand Dynamometer - DHD-1	1 pc



Designed for reliable grip-force evaluations from 0 to 90kg (200lb). It has an easy-to-read LCD display. This hand dynamometer features an electronic zero calibration system and up to 40 test data can be stored in memory. It is powered by a rechargeable Li-Ion polymer battery and data will not be lost when changing the battery. The Data Transfer Software can transfer the test results into .txt-files, which can be easily accessed using Notepad or MS-Word for editing and printing.

This Digital Hand Dynamometer hard carrying case includes a Digital Hand Dynamometer, the DTS-software and a USB cable.

Range: 0 - 90kg (200lb)

CE

SAEHAN[®]

Quality Hard Case Box



Professional light-weight aluminium caliper. Measurement arms with floating tips to assure accurate and reproducible results. 65mm scale is large and easy to read. Corrective scale for sex and age included in multilingual manual.

- Professional, very accurate unit with spring loaded levers and low-pressure bearings for constant pressure.
- Scale permits reading up to 65mm
- Aluminium casted to insure years of reliable use.
- Includes carrying case
- CE marked and FDA approved



Quality Soft Pouch Case



The Plastic Skinfold Caliper from Baseline is the inexpensive alternative for skinfold analysis. Spring loaded arm assures reproducible “pinch”. Read directly from the 50mm scale. Ideal instrument for screening large population. The Plastic Skinfold Caliper comes with a booklet and tables.

Enjoy the ability to measure body fat easily, by yourself, in the privacy of your own home, with the reliability and accuracy that you expect from world class training tools. Recommended in Body-for-LIFE and endorsed by the World Natural Bodybuilding Federation, Accu-Measure® Personal Body Fat Testers have gold standard accuracy to within 1.1% of underwater weighing results. Each Accu-Measure® Fitness 3000 model comes with:

- An original Accu-Measure® Personal Body Fat Tester
- Body Fat Measurement Instructions
- Men’s and Women’s Body Fat Measurement Charts
- Body Fat Tracking Charts with the Right Way to Weigh
- Questions and Answers on Body Fat and Calipers and Body Fat Tips



The FatTrack® FITNESS TK Body Transformation Toolkit enables you to measure (and track) Body Fat %, Lean Body Mass, your workouts, macronutrient information and more by yourself - Easily, accurately and in the privacy of your own home!

Each FatTrack FITNESS TK Includes:

- Updated FatTrack® Fitness Digital Body Fat Caliper
- User Manual with instructions
- Body Tracker Software
- MyoTape Body Tape Measure
- FREE copy of “Improve Your Measuring Skill” with practical pointers for getting the best measurement readings and valuable information on ideal weight and muscle mass.

Reference	Description	Unit
08-040101	Saehan Skinfold Fat Caliper Profi	1 pc
08-040104	Baseline Skinfold Fat Caliper Plastic - Black	1 pc
08-040103	Skinfold Fat Caliper Plastic - White	1 pc
08-040102	Skinfold Fat Caliper Digital	1 pc

RESISTIVE EXERCISE
HAND EXERCISE
UPPER & LOWER BODY EXERCISE
WELLNESS
FITNESS
STRENGTH
THERMAL TREATMENT
MEASUREMENT INSTRUMENTS

SAEHAN HYDRAULIC PINCH GAUGE

The Hydraulic Pinch Gauge uses the improved hydraulic system of the hand dynamometer to assure convenience, product reliability, measurement accuracy and repeatability. This results in a more accurate test result for all pinch tests.

Range: 0 - 20kg (45lb)

Quality Soft Pouch Case

Grip **SAEHAN**®



Reference	Description	Unit
08-020101	Saehan Hydraulic Pinch Gauge	1 pc



SAEHAN DIGITAL HAND DYNAMOMETER WITH G-STAR™ SOFTWARE - DHD-3

Quality Hard Case Box

The DHD-3 Digital Hand Dynamometer (SH1003) provides the same features as the DHD-1 when used as a stand-alone device, but adds automated Rapid Exchange Grip Testing. Using Auto Mode, up to 10 strength tests for each hand as well as the time allowed to switch hands can be configured to automate the testing procedure.

The Grip Strength Testing and Research (G-STAR) software extends the DHD-3 capabilities even further. G-STAR is an easy to use, yet powerful software tool which automates grip strength testing and endurance testing in both clinical and research environments. All patient information and their test results are stored in an Access database which includes normative score tables for comparison based on age and gender. Maximum grip strength and grip endurance tests are graphically displayed during testing and can be saved in the database with their associated patient information. In addition, tests saved in the DHD-3 itself when used as a stand-alone device, can be imported into the database when re-connected to the PC using G-STAR.

Range: 0 - 90kg (200lb) / Minimum requirements: Windows XP + USB port

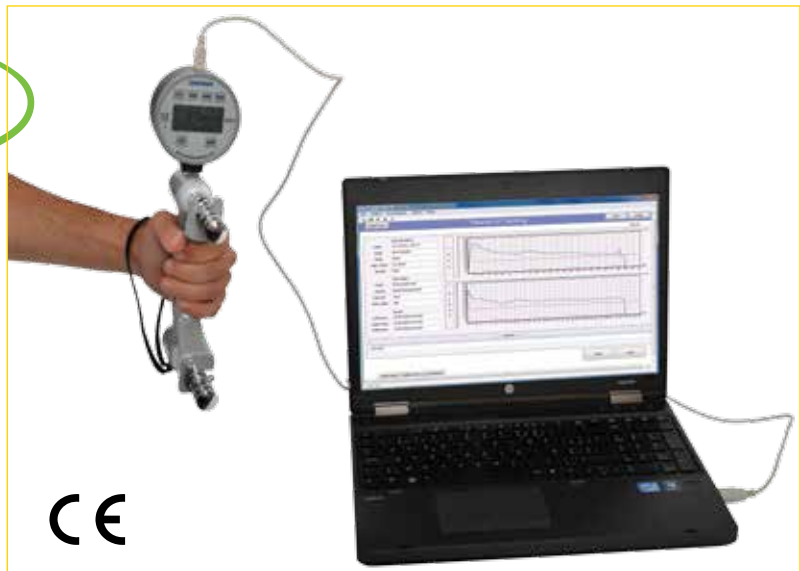

Reference	Description	Unit
08-010202	Saehan Digital Hand Dynamometer - DHD-3 (Incl. G-STAR software)	1 pc

Grip **SAEHAN**®

RESISTIVE EXERCISE

HAND EXERCISE

UPPER & LOWER BODY EXERCISE

WELLNESS

FITNESS

STRENGTH

THERMAL TREATMENT

MEASUREMENT INSTRUMENTS

Reference	Description	Unit
08-020301	Psytech Finger Flexion / Extension Gauge	1 pc

The Psytech™ gauge measures individual finger flexion strength and extension strength. Separate scales record each measurement in both pounds and kilograms. Maximum reading remains until reset.

Flexion capacity: 9kg
Extension capacity: 2,2kg

Dimensions: 10 x 15 x 10 (mm)



INCLINOMETER



Baseline's Bubble® and Digital Inclinometers are used to measure range-of-motion (ROM).



Reference	Description	Unit
08-060101	Bubble Inclinometer	1 pc
08-060201	Baseline® Digital Inclinometer	1 pc

SCOLIOMETER



Scoliometers are inclinometer designed to measure trunk asymmetry or Angle of Truncal Rotation (ATR) used in scoliosis screening programmes.

Reference	Description	Unit
08-060102	Pedi-Scoliometer	1 pc
08-060104	Baseline® Plastic Scoliometer	1 pc

SAEHAN SMEDLEY HAND DYNAMOMETER



The Smedley spring-type Dynamometer has been successfully used for many years to measure grip strength. Both are very accurate and easy to use. The ergonomic handle is adjustable to fit all hand sizes. Unit is calibrated in kilograms and pounds. Stored in a soft carrying case.

Range: 0 - 100kg (220lb)

Grip **SAEHAN**® **CE**



Ergonomic Handle

Quality Soft Pouch Case

Reference	Description	Unit
08-010401	Saehan Smedley Hand Dynamometer - Ergonomic Handle	1 pc
08-010402	Saehan Smedley Hand Dynamometer - Standard	1 pc

SAEHAN SQUEEZE DYNAMOMETER



Quality Soft Pouch Case

The Squeeze (bulb) Dynamometer is the inexpensive way to reliably measure hand and finger strength. The dynamometer has an indicator dial that remains at the maximum reading until reset. Unit is calibrated in pounds and kilograms.

Range: 0 - 70kg (150lb)

CE Grip **SAEHAN**®

Reference	Description	Unit
08-010301	Saehan Squeeze Dynamometer 70kg	1 pc

SAEHAN BACK-LEG-CHEST DYNAMOMETER

Reference	Description	Unit
08-010601	Saehan Back-Leg-Chest Dynamometer	1 pc

Measure strength of back, leg and chest. Base provides secure footing. Chain length is adjustable to accommodate for height differences or to vary the point of force application. Shows pounds and kilograms. Pointer remains at maximum until reset. Comes fully assembled with 1,5m chain. Range: 0 - 300kg (660lb)

CE Grip **SAEHAN**®



PUSH-PULL DYNAMOMETER



A simple, easy-to-use, ergonomically designed instrument that objectively measures push, pull and lift forces for manual muscle testing, functional capacity evaluation and job task evaluation at a remarkably affordable price. Because the instrument is lightweight, small and portable, you can perform precise, objective evaluations in your office or at the patient's location. The easy-to-attach dual grip handle can be used when measuring larger forces. Lift platform and chain to perform lifting evaluation not included.

Range: 0 - 45kg (100lb)

Quality Hard Case Box



Reference	Description	Unit
08-010501	Hydraulic Push-Pull Dynamometer	1 pc
08-010502	Dual Grip for Push-Pull Dynamometer	1 pc



The Plastic set (upper picture) includes:

- Plastic Goniometer 15 cm | 0° to 360° per 1°
- Plastic Goniometer 20 cm | 0° to 360° per 1°
- Plastic Goniometer 30 cm | 0° to 360° per 1°
- Rulong Goniometer 20 cm | 0° to 360° per 2°
- Pocket Goniometer 15 cm | 180°
- Plastic Flexion-Hyperextension goniometer



The Steel set (lower picture) includes:

- Robinson pocket goniometer 15cm - 180°
- Stainless steel goniometer 35cm - 180°
- Stainless steel goniometer 35cm - 360°
- Stainless steel finger goniometer 15cm
- X-ray goniometer 20cm - 180°
- Stainless steel goniometer 20cm - 180°



Reference	Description	Unit
08-030211	Saehan Goniometer Set Stainless Steel 6 pieces	Set
08-030121	Saehan Goniometer Set Plastic 6 pieces	Set



SAEHAN PLASTIC GONIOMETER

Clear plastic permits observation of joint's axis of motion, and its range of motion. The 360° head has three scales calibrated to be used with ISOM (International Standard Of Measurements, STFR) system.

Reference	Description	Unit
08-030101	Saeahan Plastic Goniometer 15cm 0° to 360° per 1°	1 pc
08-030102	Saeahan Plastic Goniometer 20cm 0° to 360° per 1°	1 pc
08-030103	Saeahan Plastic Goniometer 30cm 0° to 360° per 1°	1 pc
08-030111	Saeahan Rulong Goniometer 20cm 0° to 360° per 2°	1 pc
08-030112	Saeahan Pocket Goniometer 15cm 180°	1 pc



15cm Goniometer

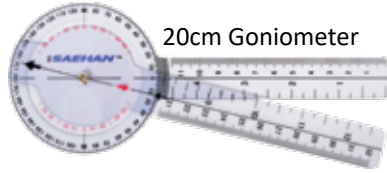

20cm Goniometer

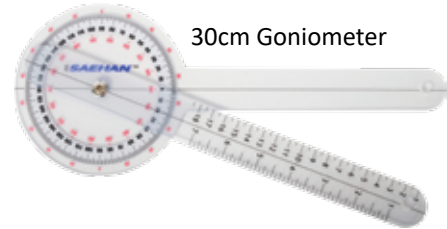

30cm Goniometer



Rulong Goniometer

This clear plastic goniometer has a 20cm linear scale calibrated in cm and 0 to 360° per 2°.

SAEHAN®



Pocket Goniometer

The pocket goniometer is an inexpensive clear plastic goniometer with a linear scale.

SAEHAN STAINLESS STEEL GONIOMETER

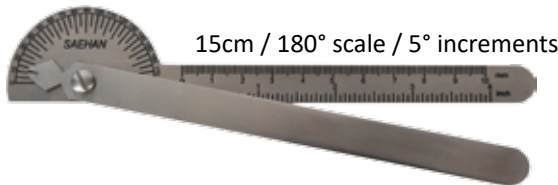

15cm / 180° scale / 5° increments



Extra long armst for measuring all joints

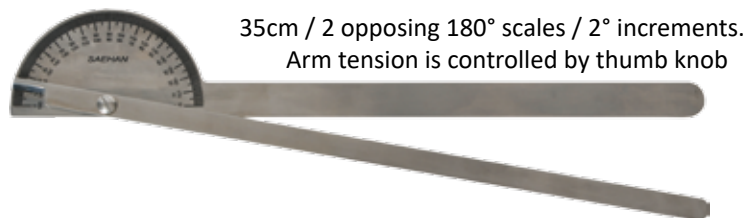

35cm / 2 opposing 180° scales / 2° increments.
Arm tension is controlled by thumb knob

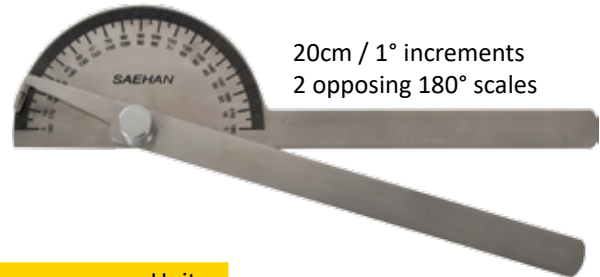

20cm / 1° increments
2 opposing 180° scales

Reference	Description	Unit
08-030201	Saeahan Stainless Steel Goniometer 15cm 180°	1 pc
08-030202	Saeahan Stainless Steel Goniometer 20cm 180° x 2	1 pc
08-030203	Saeahan Stainless Steel Goniometer 35cm 180° x 2	1 pc
08-030204	Saeahan Stainless Steel Goniometer 35cm 360°	1 pc



SAEHAN®

SAEHAN FINGER GONIOMETER

Stainless Steel Goniometer measures range-of-motion of finger joints. Head has two opposing 180° scales marked in 5° increments. A linear scale in centimetres is on arm. Small Finger = 9cm / Standard Finger = 15cm

SAEHAN®

Reference	Description	Unit
08-030301	Saeahan Finger Goniometer 9cm 180° per 5°	1 pc
08-030302	Saeahan Finger Goniometer 15cm 180° per 5°	1 pc



BASILINE GONIOMETER



30cm Plastic Goniometer

CE



30cm Plastic Goniometer - HiRes™



9cm Plastic Finger Goniometer



Absolute+Axis® Attachment

9cm Plastic Finger Goniometer - HiRes™

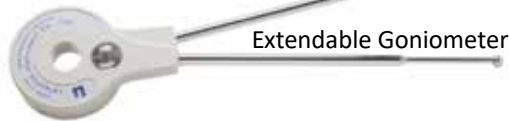

Extendable Goniometer



20cm Digital Metal Goniometer

Reference	Description	Unit
08-030401	Baseline® Plastic Absolute+Axis® Goniometer - 30cm 360°	1 pc
08-030402	Baseline® Plastic Absolute+Axis® Goniometer - HiRes™ - 30cm 360°	1 pc
08-030411	Baseline® Plastic Absolute+Axis® - Attachment Only for 30cm Goniometer	1 pc
08-030501	Baseline® Digital Metal Absolute+Axis® Goniometer - 20cm 180°	1 pc
08-030601	Baseline® Plastic Finger Goniometer - 9cm Flexion to Hyper-Extension	1 pc
08-030602	Baseline® Plastic Finger Goniometer - HiRes™ - 9cm Flexion to Hyper-Extension	1 pc
08-030701	Lafayette Extendable Goniometer with magnification - 24cm - 66cm 180°	1 pc

MEASUREMENT TAPE



Measurement Tape with Gulick Attachment



Finger Circumference Gauge

CE

Measurement Tape with Hands-free Attachment

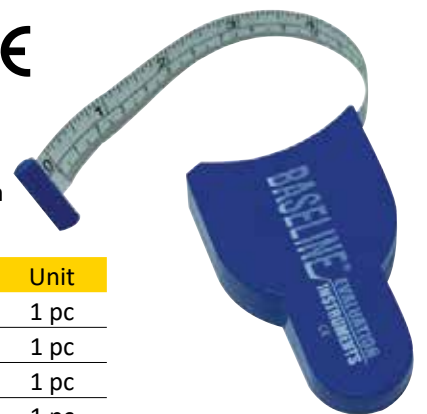

Reference	Description	Unit
08-080101	Baseline® Measurement Tape with Gulick Attachment - 150cm	1 pc
08-080102	Baseline® Measurement Tape with Gulick Attachment - 180cm	1 pc
08-080103	Baseline® Measurement Tape with Hands-free Attachment - 150cm	1 pc
08-080201	Baseline® Finger Circumference Gauge - 15cm	1 pc

PROTRACTOR

Measure range-of-motion for all major articulations, cervical rotation, lateral flexion of the head and anterior-posterior cervical flexion. Bubble® level assures measurement is made on horizontal plane. Two 180° opposing scales in 5° increments.

CE



Reference	Description	Unit
08-030801	Baseline® Large Joint Protractor	1 pc

RESISTIVE EXERCISE

HAND EXERCISE

UPPER & LOWER BODY EXERCISE

WELLNESS

FITNESS

STRENGTH

THERMAL TREATMENT

MEASUREMENT INSTRUMENTS

HAMMER

Babinsky Hammer
Pointed bottom can be used as gross aesthesiometer

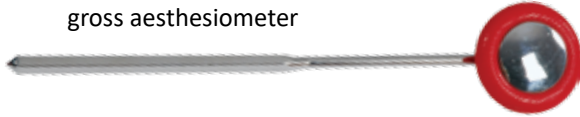

Buck Hammer
Two heads for cutaneous sensation evaluation. Comes with a needle and a brush

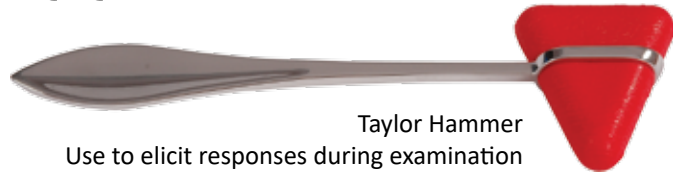
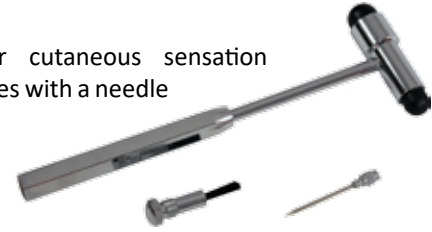

Taylor Hammer

Use to elicit responses during examination

Reference	Description	Unit
08-050101	Buck Hammer	1 pc
08-050102	Babinsky Hammer	1 pc
08-050103	Taylor Hammer	1 pc

WARTENBURG PINWHEEL

Elicit cutaneous sensory and pain perception responses.

Reference	Description	Unit
08-050201	Wartenburg Pinwheel	1 pc



TUNING FORK

These aluminium Tuning Forks are developed to evaluate hearing and vibratory sensation.

Reference	Description	Unit
08-050301	Tuning Fork 128cps	1 pc
08-050302	Tuning Fork 256cps	1 pc



DISCRIMINATOR

Touch-Test™ 2-point Discriminator



Baseline® 2-point Discriminator



Baseline® 3-point Discriminator



Dellon 2-point Disk-Criminator, 2 disk set



Reference	Description	Unit
08-050202	Dellon 2-point Disk-Criminator, 2 disk set	1 pc
08-050203	Touch-Test™ 2-point Discriminator	1 pc
08-050204	Baseline® 2-point Discriminator	1 pc
08-050205	Baseline® 3-point Discriminator	1 pc

SIT & REACH UNIT

RESISTIVE
EXERCISE

HAND
EXERCISE

UPPER & LOWER
BODY EXERCISE

WELLNESS

FITNESS

STRENGTH

THERMAL
TREATMENT

MEASUREMENT
INSTRUMENTS



Reference	Description	Unit
08-060103	Sit & Reach Unit	1 pc

When using the Sit & Reach unit you sit with your feet against the "sit and reach box" and flex forward moving the slide bar. Flexion is read directly from the calibrated bar.

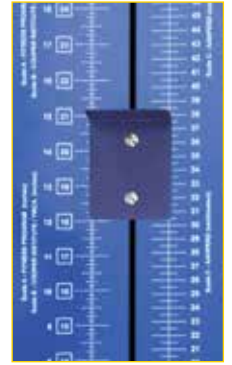

MONOFILAMENT



Monofilament evaluators are used to measure cutaneous sensory perception threshold.



08-050401
08-050411

08-050402
08-050412

Reference	Description	Unit
08-050401	Baseline® Tactile™ Monofilament - LEAP Program - Disposable - 5.07 - 10 gram	1 pc
08-050402	Baseline® Tactile™ Monofilament - LEAP Program - Disposable - 5.07 - 10 gram	20 pcs
08-050411	Baseline® Tactile™ Monofilament - ADA Program - Disposable - 5.07 - 10 gram	1 pc
08-050412	Baseline® Tactile™ Monofilament - ADA Program - Disposable - 5.07 - 10 gram	20 pcs
08-050421	Baseline® Tactile™ Monofilament - 2-piece Set - Normal - 2.83, 3.61 gram	Set
08-050422	Baseline® Tactile™ Monofilament - 5-piece Set - Hand - 2.83, 3.61, 4.31, 4.56, 6.65 gram	Set
08-050423	Baseline® Tactile™ Monofilament - 6-piece Set - Foot - 2.83, 3.61, 4.31, 4.56, 5.07, 6.65 gram	Set
08-050424	Baseline® Tactile™ Monofilament - 20-piece Set - Complete	Set
08-050425	Baseline® Tactile™ Monofilament - 2-piece Set - Protective Sensation - 4.56, 5.07 gram	Set

SCALE



Baseline® body fat scale is made with tempered glass. This scale measures weight, body fat and water % and memorises data up to 8 persons. Measurements range from 4% - 45% body fat; 37.8% - 66% body water and 330lb/150kg weight capacity. The Required 1 x 3V battery is included.

Resolution:
- 0.1kg BF
- 0.1% water

Dimensions: 35cm x 35cm x 6cm
Product weight: 2kg

Reference	Description	Unit
08-070101	Baseline® BMI Body Fat Scale	1 pc

PRIVATE LABELS



MSD-Band is a great product, but you would like your brand on the band, loop, superloop...? We'll do it!
Together with our manufacturers from all the products in our range, we can create your desired product with the look you want. We can replace our logo with yours, change the colour, even the packaging can be tweaked to your needs. Private Labels will allow you to design the product the way you want to match it to your company's identity.

Private Label products have the same quality as all our products, but are putting your brand in the spotlights. This is perfect if you need a homogeneous range of products or want to increase your brand awareness. Or maybe you're looking for a one time opportunity: a promotional product during your company's special occasion, a gift for visitors or an event you're supporting?

Please contact us for more information about pricing and volume.

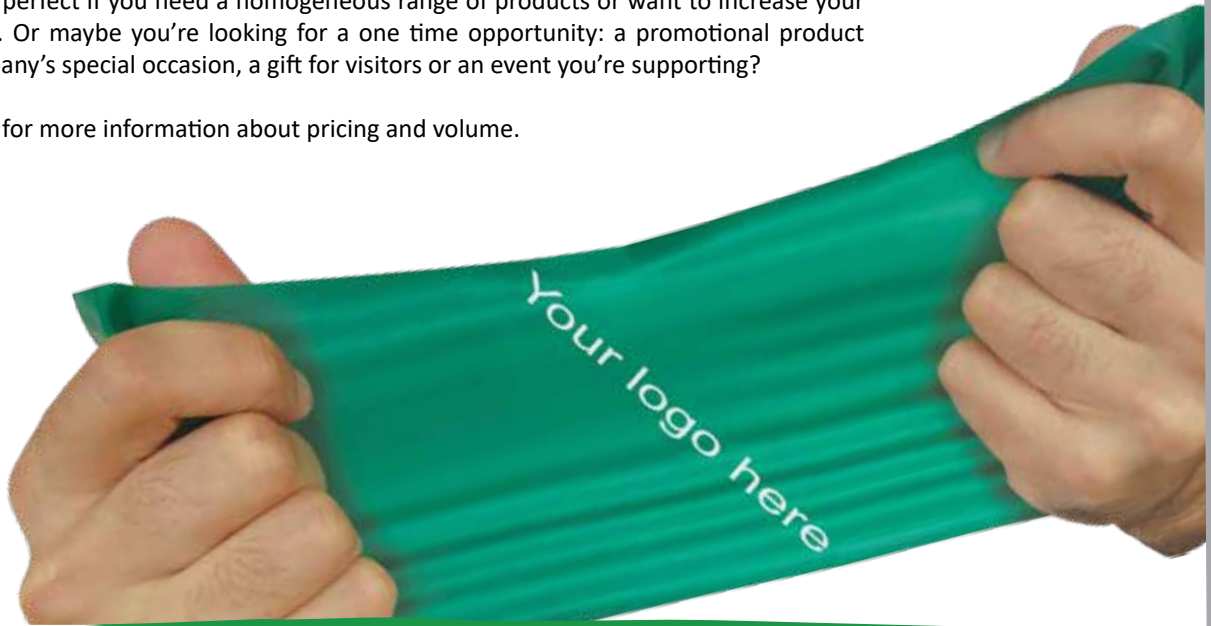

CREATE YOUR PRODUCT / PRODUCT KIT *



Do you have a project in mind but you don't know how to start? Do you need some support to bring your plans to life? Do you want to target a specific group of customers with a unique sport or rehabilitation kit? Or are you looking for original gifts for special occasions?

As master distributor and manufacturer we have the worldwide contacts and resources to achieve the best possible result. Our product developer will help you to go through the required steps and avoid any inconvenient surprises.

Contact us at MSD Europe and we will help you to bring your product plans to life or create that special sport or rehabilitation kit. We will assist you to find the right products and packaging for a successful project.

* Starting from a specific volume/value, please ask for more information.

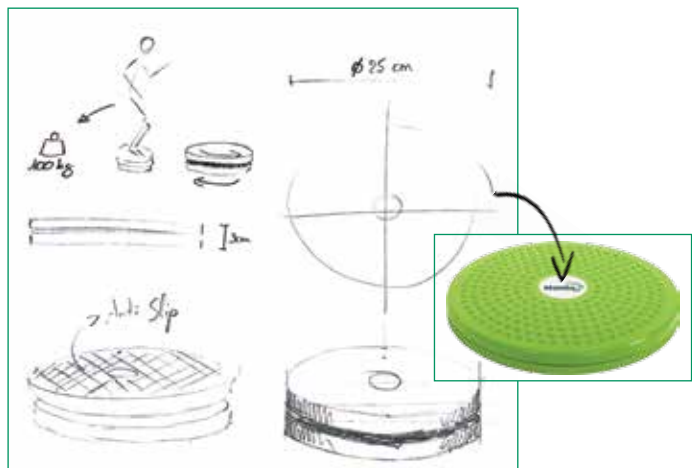

Measurement Instruments are calibrated at manufacturing with a full one year guarantee, before sending them to users all over the world. Ideally, these instruments should be recalibrated every year.

In order to make this happen in an easy and inexpensive way, Hydraulic Hand Dynamometers (Saehan, Jamar, Baseline...) and Hydraulic Pinch Gauges are recalibrated by our experts at the MSD Europe Service Centre in Tisselt - Belgium. This operation consists of re-establishing the exact relationship between the force applied to a dynamometer and the measurement it shows. Small repairs can be done as well.

Simply send your request to our customer service department for a return authorisation number. After each recalibration, you will receive an updated calibration certificate, certifying accurate and repeatable test results.



If you have many calibrations to do, you might consider buying your own calibration unit.

Reference	Description	Unit
08-019901	Calibration Unit	1 pc
08-019900	Calibration & Repair	-

MSD EUROPE REPAIR CENTRE



Since machines are designed and assembled by humans, they are not flawless. That is why MSD Europe installed an inhouse repair centre, to swiftly and correctly solve any problems that may occur with our products.

No matter what the cause, be it faulty fabrication or misuse, our technician will shine his light on the problem.

Send an email to our customer service department to inform us on the type of problem and the serial number/production date of the device. After our authorisation, please send over the patient, accompanied by your name and client number and a brief description of the symptoms. We'll do our best to have him cured in no time.

3-in-1 Foam Roller	43	Hammers	77	Prohands	26
AB Ball	47	Hand Evaluation Kit	68	Protractor	76
Adjustable Hand Grip	24	Hand Grip	24	Pull Buoy	58
Aerobic Step	48	Handles	22	Pulley	18, 19
Ankle Weight	58	Handmaster Plus™	28	Pumps	46
Ankleciser	23	Health Bounce Pod	39, 54	Push-Pull Dynamometer	73
Aquatic Products	58	Hollow Foam Roller	43	Putty	30, 31
Babinsky Hammer	77	Hot/Cold Pack	64	Rehab Trampolines	39, 54
Back Wrap	65	Hydraulic Hand Dynamometer	68, 69	Repair Centre	80
Back-Leg-Chest Dynamometer	73	Hydraulic Pinch Gauge	71	Rope Pulley	18, 19
Backnobber® II	45	Incline boards	37	Rotation Handles	17, 22
Balance Boards	51, 53	Inclinometer	72	Saehan Cycles	34
Balance Pads	53	Index® Knobber II	45	Safety handles	22
Balance Trainers	51	Jacknobber® II	45	Scale	78
Ball Accessories	46	Jumping Fitness Trampoline	38, 55	Scoliometer	72
Ball Stabilizer	46	Kettlebells	61	SensAir Cushion	41
Ball Stacker	46	Knee Rope Pulley	19	Shoulder Pulley	18, 19
Body Fat Scale	78	Loops	20	Sit & Reach Unit	78
Body Twister	48	Mat (Hanger)	48	Sitting Wedge	41
Bounce Pod™	39, 54	Massage Balls, Ring & Roll	45	Smedley Hand Dynamometer	73
Buck Hammer	77	Massage Tools	43, 45	Soft Dumbbell	59
Calibration, Repair & Trade-in	80	Medicine Ball	62	Soft Handles	22
Calibration Unit	80	Massage Stick	43	Soft-Over-Ball	42
Comfort Putty	31	Measurement Tape	76	SoftMeds	62
Create your Product/Kit	80	Monofilament	78	Sport Pack	65
Cuff-Ring Tube Loop	16	MSD-Band	9	Squeeze Ball	31
CuraMotion	36	MSD-Band Accessories	22	Squeeze Dynamometer	73
Cushions	41	MSD-Band Ankleciser	23	Squeeze Egg	31
Digi-Extend®	26	MSD-Band Bar	23, 56	Stainless Steel Goniometers	74 - 76
Digi-Flex®	26	MSD-Band Global	11, 57	Standard Cushion	41
Digital Hand Dynamometer	69, 71	MSD-Band Global Loops	20, 56	Standard Pedal Exerciser	35
Discriminator	77	MSD-Band Global Tubing	14, 57	Stepping Stones	44
Door Anchor	22	MSD-Band Global Superloop	21, 56	Superloop	21
Dumbbells	59	MSD-Band Latex Free	13	Swim Noodle	58
Dynadome	49	MSD-Band Loops	20	Swimfit Products	58
Dynamometers	68, 69, 71	MSD-Band Tubing	15 - 17	Taylor Hammer	77
Ekilibre Balance Plate	50	O-Ring Tube Loop	16	Theraflex™ Putty	30
Ergonomic Foam Roller	43	OxyCycle 1	32	Thumb Lock Wrist Weights	60
Exercise Mat	48	OxyCycle 2	33	Torex®	66
Eye Mask	65	OxyCycle 3	33	Trampolines	38, 39, 54, 55
Fat Calipers	70	OxyCycle Pedals	32	Tubing	14 - 17, 57
Figure 8-Ring Tube Loop	16	Palmassager™	45	Tuning Fork	77
Finger Gauge	72	Para Pro - Paraffin Bath	63	Universal Assist	22
Finger Goniometer	75, 76	Paraffin	63	Wallmount	21, 22
Fit Stretch	41	Peanut Ball	47	Wartenburg Pinwheel	77
Fitness Trampolines	38,55	PearlPack	65	Wooden Balance Boards	53
Flex-Grip	28	Pedal Exercisers	32 - 35	Wooden Fit Stretch	40
Flex-Ion	27	Pedi-Scoliometer	72	Wooden Incline Boards	37
Floating Belt	58	Pinch Gauge	71	Work Station	49
Foam Hand Grips	24	Pilates	42	Wrist & Ankle Weights	60
Foam Rollers	42,43	Plastic Goniometers	74 - 76	Wrist Exerciser	24
Goniometers	74 - 76	Power-Web®	28,29	Yoga Set	44
G-STAR™ software	71	Private Label	79		
Gym Ball	47				

1. Terms: prepayment, unless otherwise specified. Buyer should bear all bank charges.
2. Minimum purchase value: All orders must have a minimum purchase value of € 250,00. For smaller orders, an administration fee of € 10,00 will be charged.
3. Freight Terms: prices are ex-works Tisselt, Belgium. All shipping/delivery costs are at charge of the buyer, unless otherwise specified.
4. Prices: all prices for merchandise purchased are based on seller's price list in effect on the time of shipment. Prices can be subject to change without notice.
5. Claims: unless otherwise provided for herein, claims of any kind in goods sold by seller shall be made by buyer to seller, in writing, within a period of seven days after such goods are delivered to buyer.
6. Credit and Exchange: written authorisation must be obtained before returning merchandise for credit or exchange. When requesting return authority, product lot number and/or manufacturing date and/or expiration date should be included.
7. Finance Charge: a finance charge of 1% per month (12 % per annum) will be added to all amounts past due. A penalty of 15% on value, with a minimum of €40,00 for late payment will be added. Terms of payment are from date seller's invoice and not contingent upon delivery.
8. Governing Law: all disputes arising out of all sales by seller to buyer shall be governed by the laws of Belgium. Only the courts covering the territory of the company's operational seat will be qualified in case of dispute.
9. Warranties: seller warrants that it has good title to the goods purchased by buyer and that its good will conform to buyer's specifications, if any, except as otherwise provided herein. All other warranties, whether express or implied, and including, but not limited to, the warranty of merchantability and fitness for a particular purpose are excluded. In all events, buyer's sole and exclusive remedy shall be limited to the amount of the purchase price of any product on which a claim is made as its exclusive remedy for breach of the warranty expressed herein and for negligence and otherwise. Under no circumstances shall seller be liable to buyer or any other person for consequential or incidental damages.
10. Property: seller has the exclusive property on the delivered products until buyer has paid the full amount due. This also implies that if buyer does not pay in time, seller has the right to, without prenotice, claim back the delivered goods.





PROFESSIONAL CARE ON ALL DETAILS

DEPENDABLE
partner for
QUALITY
products and
SERVICE



PARALLEL BAR PRO

Contact address:



FERROX S.r.l.

+39 0438 777091

info@ferrox.it

www.ferrox.it



The Original

MSD-BAND

RESISTIVE EXERCISE SYSTEM

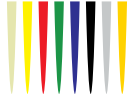

The Original

MSD-BAND

RESISTIVE EXERCISE SYSTEM



LATEX-FREE

MSD-BAND

RESISTIVE EXERCISE SYSTEM



Visit www.msd-band.com for:

- Product information
- More than 125 exercises
- HD instruction videos



LATEX-FREE

Snap-Stop®

Snap-Stop®